Michel Club

SOFAS

Antonio Citterio



Description

Michel Club is an evolution of Michel seating system. Orientation towards a technical and formal typology that resizes proportions of the frame and the cushions makes Michel Club a more traditional yet contemporary design proposal. Its 36 modular elements, 5 ottoman and linear sofas allow for a wide range of configurations. Comfortable back cushions with a headrest and additional cushions in various sizes make the seating relaxing or suitable for conversation, but always comfortable and very elegant. Michel Club is available in a wide range of fabrics and leathers from the B&B Italia collection. Combining different textures and colours allows an even greater level of personalisation of this seating system.

Technical information

Back and armrest internal frame:
tubular steel and steel profiles

Back and armrest internal frame upholstery:
Bayfit® (Bayer®) flexible cold shaped polyurethane foam, polyester fibre, polyester fibre cover

Seat internal frame:
painted tubular steel and steel profiles, multilayered wood panel, shaped polyurethane

Seat cushion upholstery:
shaped polyurethane of different density, sterilized down, polyester fibre cover

Back cushion (C65C-C50C):
upholstery : down feather + polyurethane section, typology : box style

Back cushion with roller (C65CP-C50P):
upholstery : down feather + polyurethane section + polyester fibre, typology : box style + roller

Support frame:
painted black chrome, pewter painted, bronzed nickel painted or bright brushed die-cast aluminium and extrusions

Ferrules:
thermoplastic material

Cover:
fabric or leather

Technical drawings

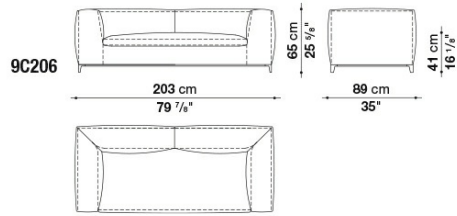

9C206

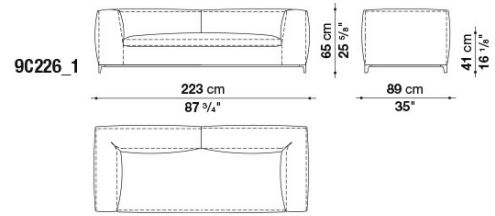

9C226_1

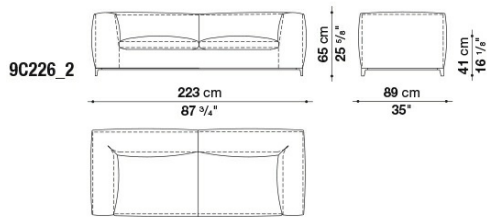

9C226_2

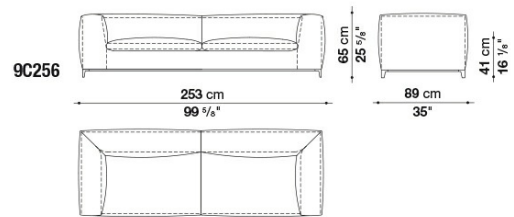

9C256

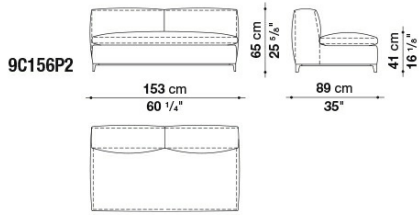

9C156P2

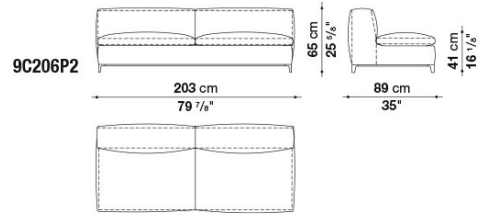

9C206P2

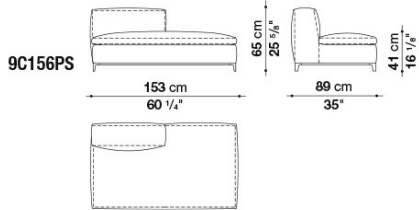

9C156PS

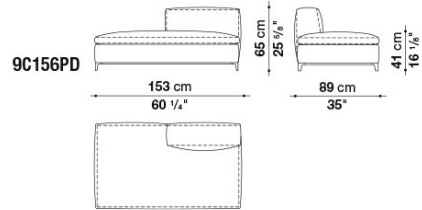

9C156PD

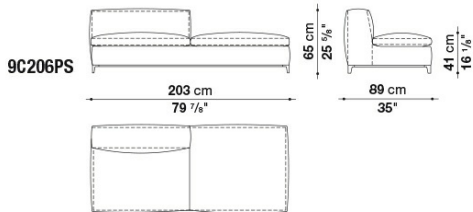

9C206PS

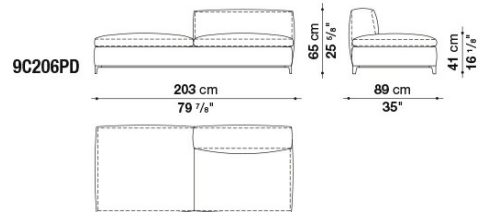

9C206PD

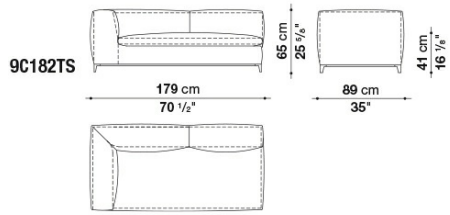

9C182TS

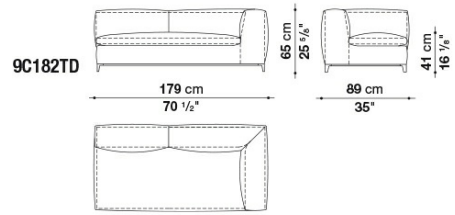

9C182TD

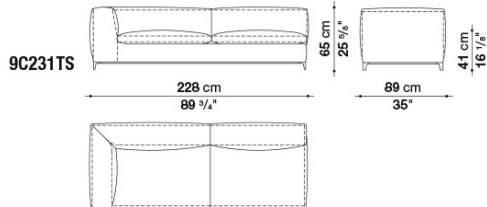

9C231TS

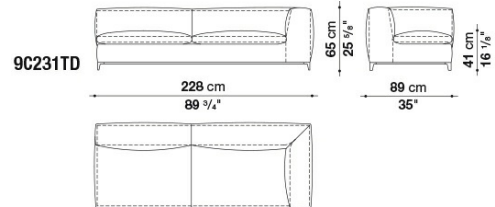

9C231TD

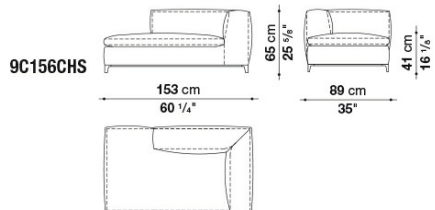

9C156CHS

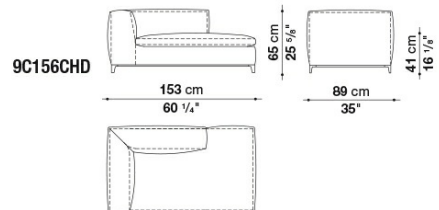

9C156CHD

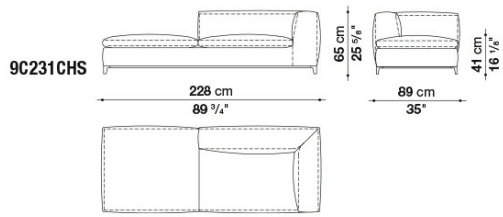

9C231CHS

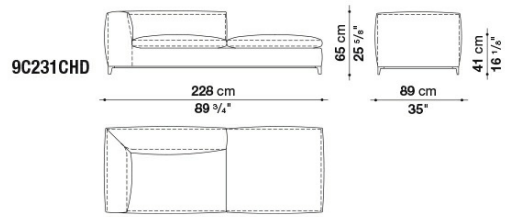

9C231CHD

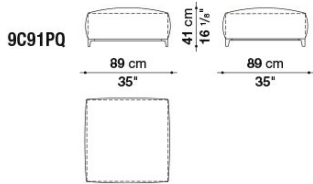

9C91PQ

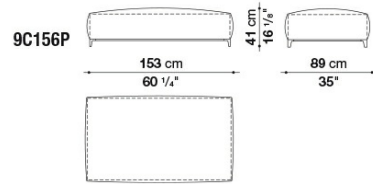

9C156P

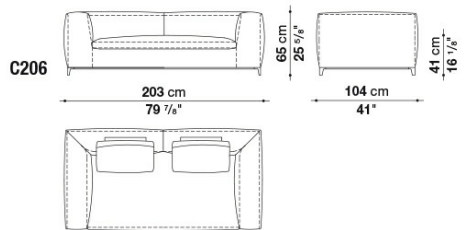

C206

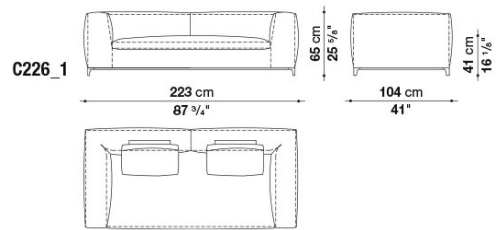

C226_1

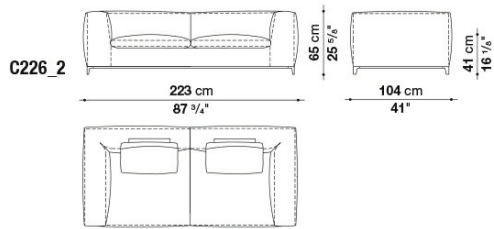

C226_2

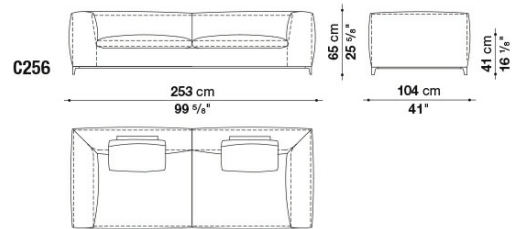

C256

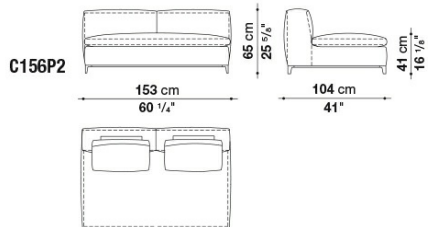

C156P2

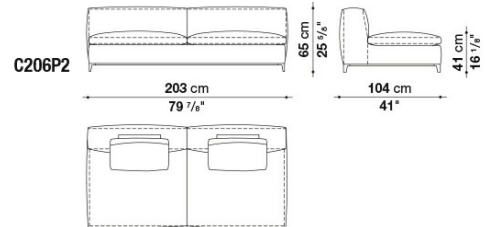

C206P2

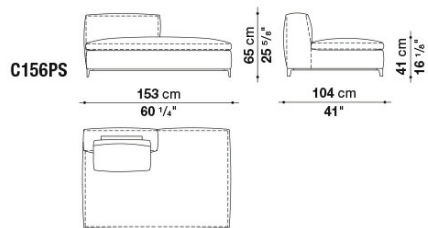

C156PS

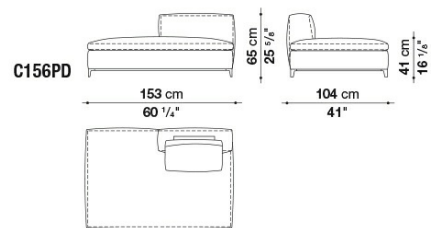

C156PD

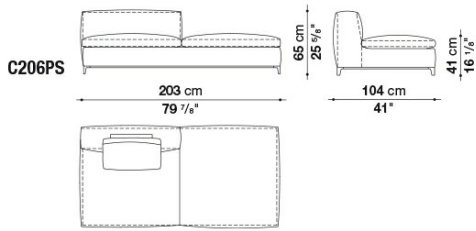

C206PS

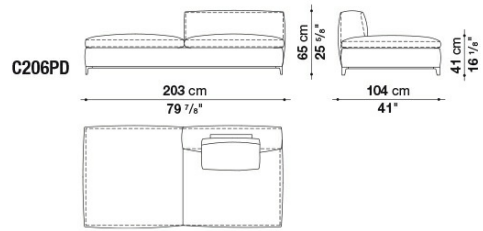

C206PD

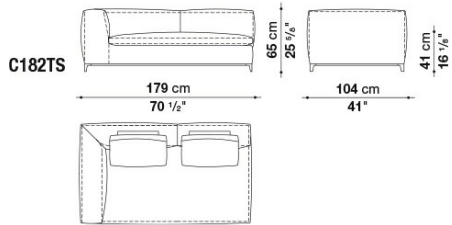

C182TS

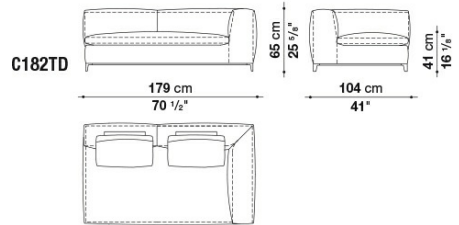

C182TD

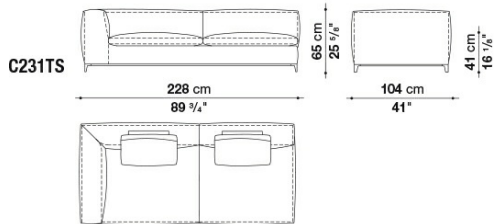

C231TS

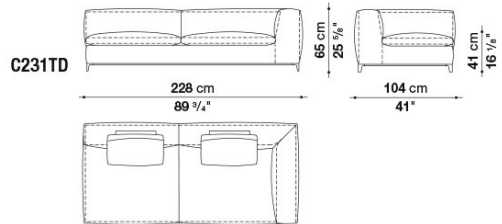

C231TD

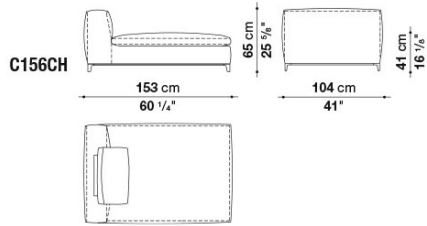

C156CH

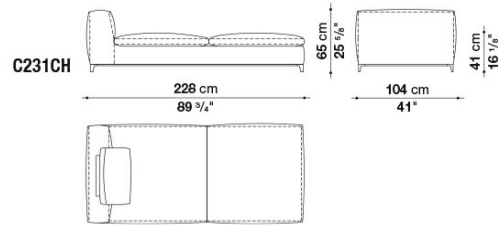

C231CH

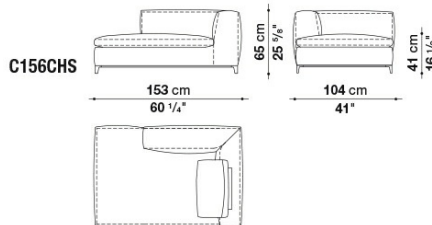

C156CHS

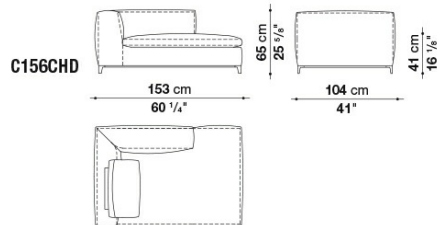

C156CHD

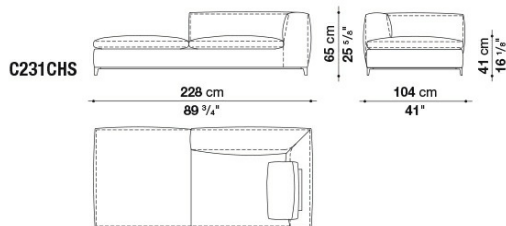

C231CHS

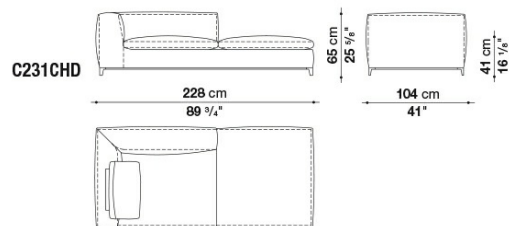

C231CHD

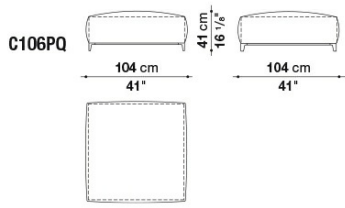

C106PQ

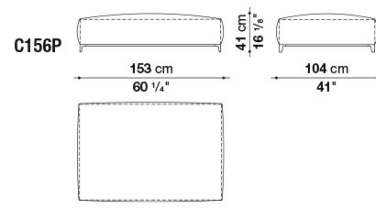

C156P

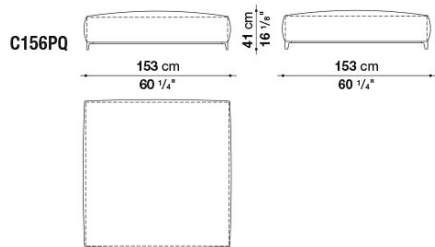

C156PQ

Compositions

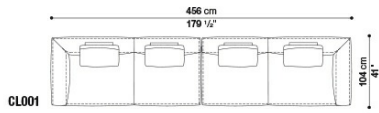

01

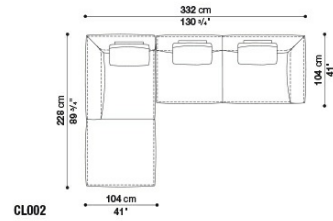

02

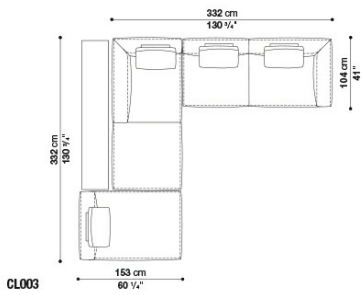

03

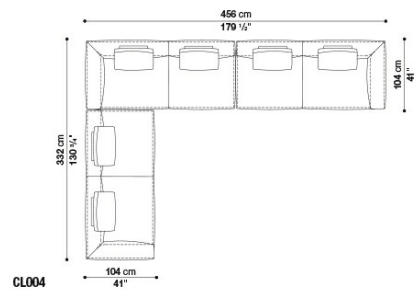

04

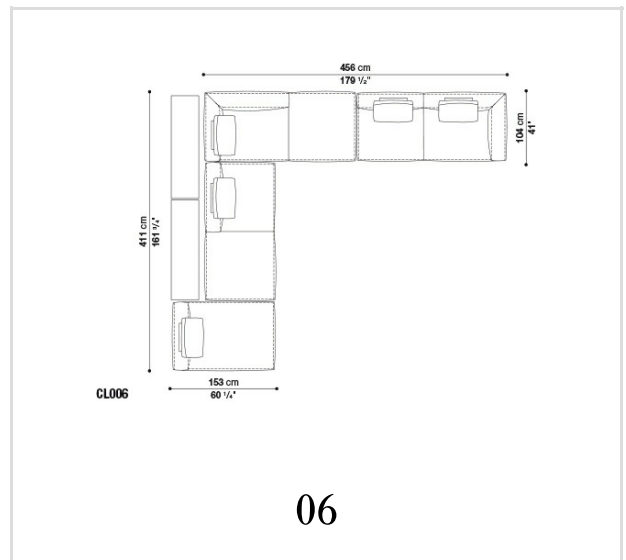
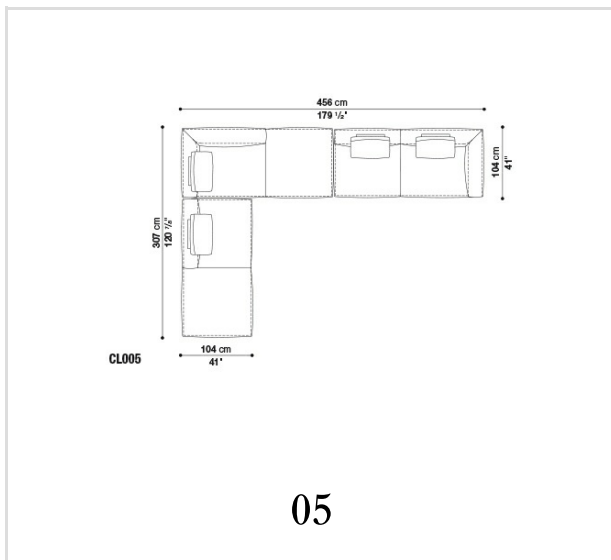

B&B Italia reserves the right to make technological and aesthetic improvements to its models, including changes to the sizes and materials, without notice. The technical drawings do not define the details of the product. The measurements shown are indicative and may undergo changes. In particular, the dimensions relevant to the padded parts are subject to usage tolerances over time caused by the normal adjustment of the padding. For the specific information, please contact the dealer closest to you.