

IOLA WITH ARMREST

by e-ggs



Iola vive il Design con un approccio internazionale, concentrandosi sull'ergonomia delle forme, mantenendo un aspetto curato e caratterizzante. Abbiamo dato alla scocca la forma di un guscio, producendola in poliuretano espanso. Sotto consiglio dei più esigenti, poi, le abbiamo tirato le orecchie così sono usciti due grandi braccioli. Iola sa di moda, ma si propone come un classico contemporaneo.

Iola shows off design with an international approach, focusing on the ergonomics of the form, ensuring a careful look, one with character. We have given the body the shape of a shell, producing it in expanded polyurethane. Then, on the advice of the hardest to please, we pulled the wings and then the two large arms came out. Iola hints at fashion but comes across as a modern classic.

DIMENSIONI | DIMENSIONS

BASIC | BASIC

lunghezza | width: 57,4 cm

larghezza | depth: 58 cm

altezza | height: 83,5 cm

altezza del sedile | seat height: 47 cm

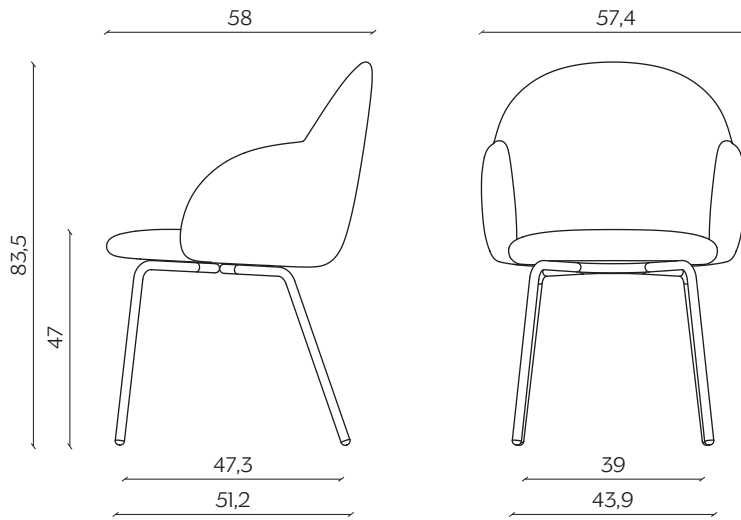

GAMBE IN LEGNO | WOODEN LEGS

lunghezza | width: 57,4 cm

larghezza | depth: 58 cm

altezza | height: 83,2 cm

altezza del sedile | seat height: 46,7 cm

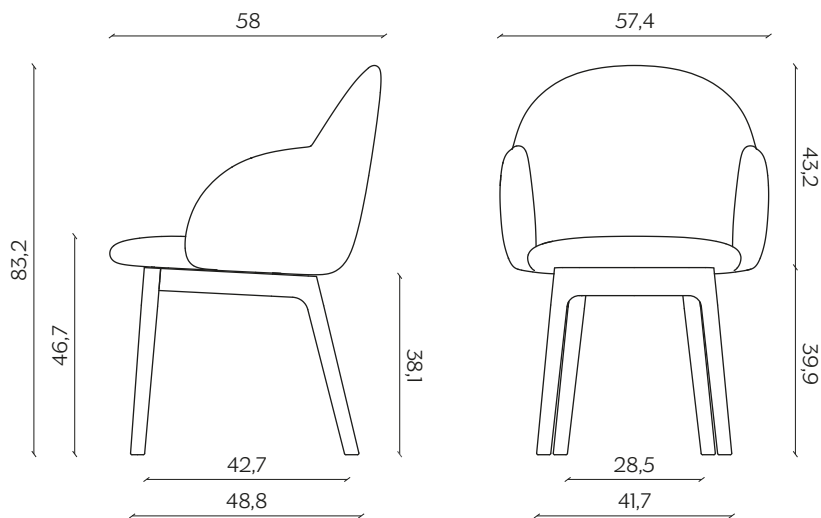

UFFICIO | OFFICE

lunghezza | width: 57,4 cm

larghezza | depth: 58 cm

altezza | height: 82,9 cm

altezza del sedile | seat height: 45,8 cm

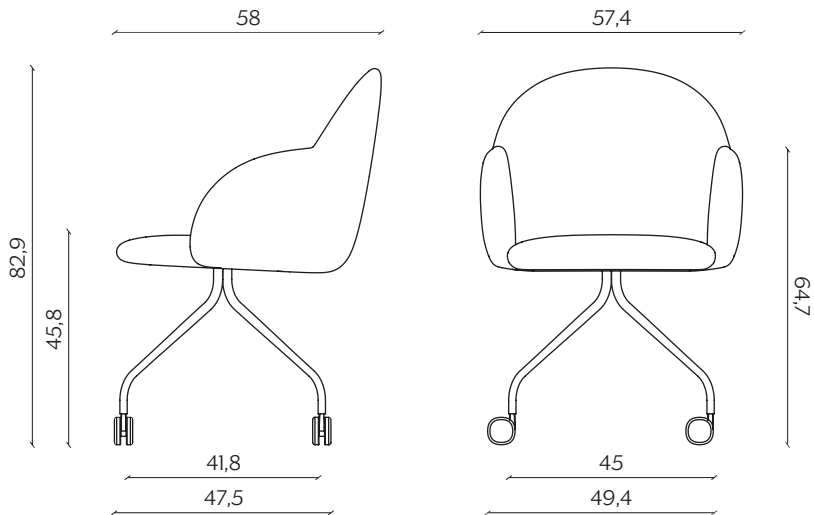

AMBIENTE | ENVIRONMENT

interno | indoor

DOWNLOAD | DOWNLOADS

la guida Cura e Manutenzione è disponibile su miniforms.com
Care and Maintenance guide is available at miniforms.com

file 2D, 3D e fotografie sono disponibili su miniforms.com
2D, 3D files and hi-res images are available at miniforms.com

FINITURE | FINISHES

GAMBE | LEGS

Legno | Wood



Frassino
Ash



Frassino Nero
Black Ash

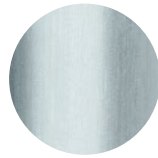

Zincato
Zinc-coated

Metallo | Metal

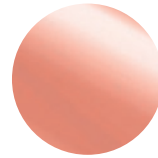

Rame
Copper

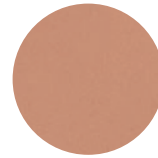

Oro Rosa Opaco
Rose Gold Matt

Laccato | Lacquer

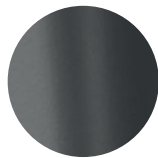

Laccato Antracite
Anthracite Lacquered



Laccato Nero
Black Lacquered

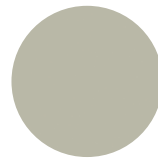

Laccato Grigio Seta
Silk Grey Lacquered

FINITURE | FINISHES

TESSUTI | FABRICS

A

Salò

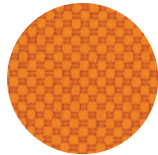

Arancio
Orange

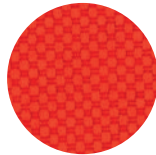

Rosso
Red



Marmellata
Jam



Grigio Chiaro
Light Grey



Marrone
Brown

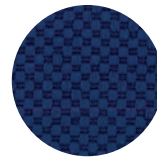

Blu Notte
Midnight Blue

Loop

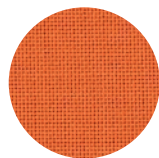

Arancione
Orange



Lime

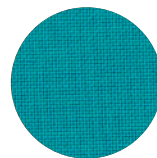

Turchese
Turquoise

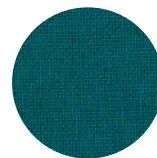

Ottanio
Teal Green

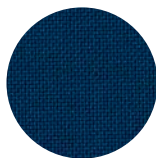

Blu Scuro
Dark Blue



Testa di Moro
Dark Brown

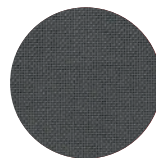

Grigio Fumo
Smoke Grey

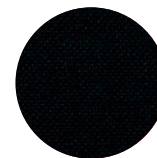

Nero
Black

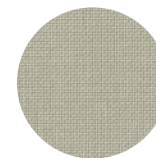

Avorio
Ivory

TESSUTI | FABRICS

A

Tramè



Beije

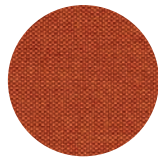

Arancio
Orange

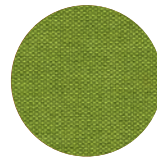

Mela
Apple

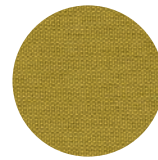

Senape
Mustard

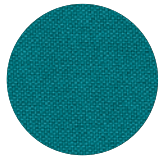

Pavone
Peacock

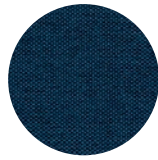

Blu Elettrico
Electric Blue

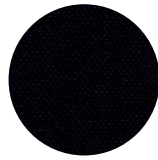

Nero
Black

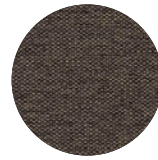

Crigio Scuro
Dark Grey

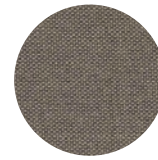

Tortora
Dove Grey

Madrid

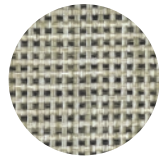

Burro
Butter

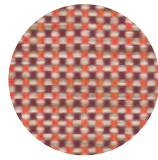

Melograno
Pomegranate



Menta
Mint

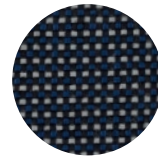

Notte
Night

FINITURE | FINISHES

TESSUTI | FABRICS

B

Kvadrat Relate

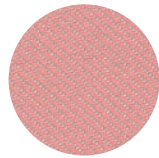

Rosa
Pink

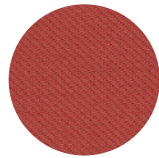

Rosso
Red

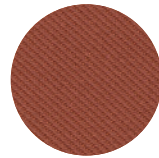

Terra
Ground



Snack

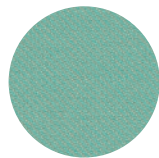

Menta
Mint

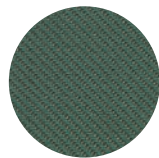

Verde Bosco
Forest Green

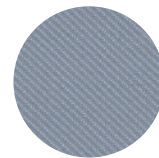

Nuvolo
Cloudy



Grigio
Grey

Lanee

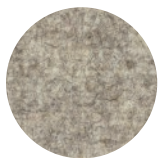

Grigio
Grey

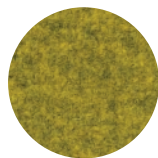

Giallo
Yellow

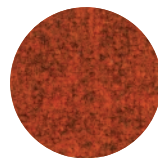

Rosso
Red

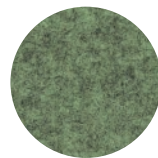

Menta
Mint

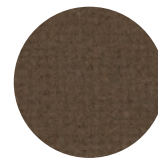

Marrone
Brown

TESSUTI | FABRICS

B

Torrilana Cubbio

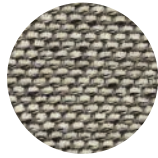

Sale e Pepe
Salt and Pepper

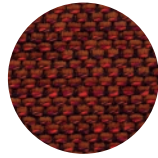

Ambra
Amber



Bordeaux

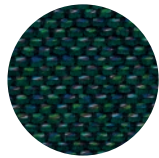

Verde Petrolio
Petrol Green

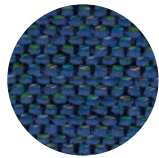

Blu Elettrico
Electric Blue



Castagna
Walnut

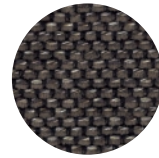

Tortora
Dove Grey

Mesh

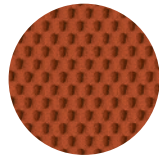

Rosso Corallo
Coral Red

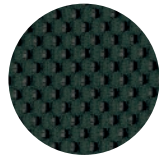

Verde Salvia
Sage Green

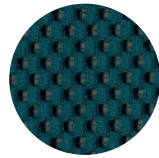

Foglia di Tè
Teal

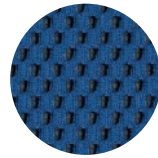

Blu Neon
Neon Blue

TESSUTI | FABRICS

B

Vescom Wilson

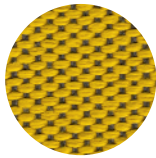

Ciallo Elettrico
Electric Yellow

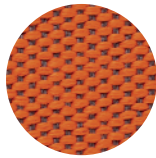

Energico
Energetic

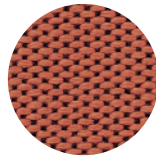

Rosé

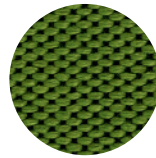

Laguna
Lagoon

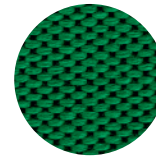

Prato
Field

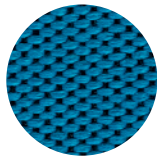

Zaffiro
Sapphire

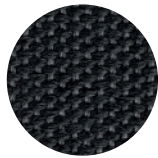

Grafite
Graphite

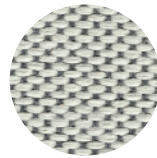

Sale e Pepe
Salt and Pepper

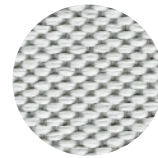

Neve
Snow

Vescom Norfolk

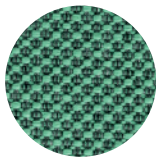

Latte e Menta
Milk and Mint

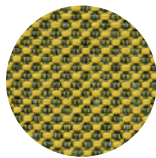

Ape
Bee

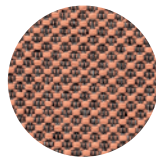

Rosa
Pink

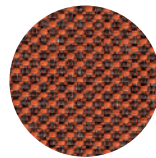

Mattone
Brick

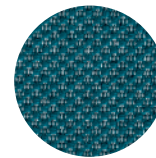

Petrolio
Petrol-Green

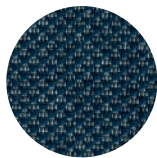

Notte
Night



Antracite
Anthracite



Sale e Pepe
Salt and Pepper

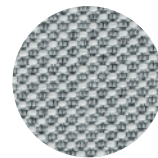

Ghiaccio
Ice

FINITURE | FINISHES

TESSUTI | FABRICS

C

Shelter Velvet



Crema
Cream



Rosa Intenso
Intense Rose



Terra di Siena
Burnt Sienna



Cammello
Camel

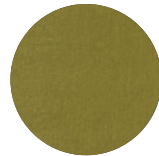

Verde
Green

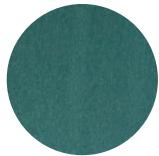

Turchese
Turquoise



Blu Notte
Midnight Blue



Testa di Moro
Dark Brown

Kvadrat Field 2

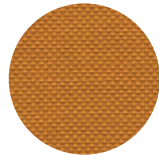

Zafferano
Saffron-Yellow

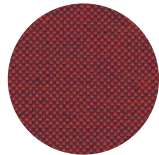

Ciliegia
Cherry

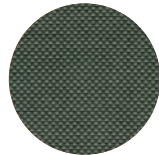

Menta
Mint

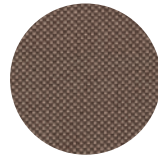

Nocciola
Hazel

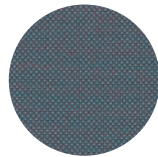

Zucchero
Sugar

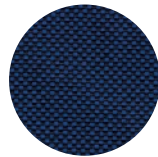

Blu
Blue

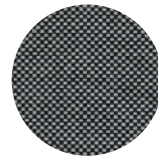

Sale e Pepe
Salt and Pepper

Torrilana Brionne



Black and White

TESSUTI | FABRICS

C

Vescom Harding

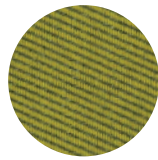

Ciallo
Yellow

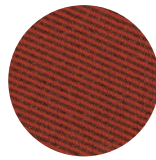

Rosso
Red

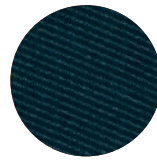

Petrolio
Blue-Green

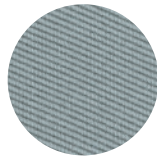

Grigio Chiaro
Light Grey

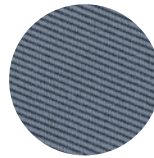

Nuvolo
Cloudy

Vescom Rolla

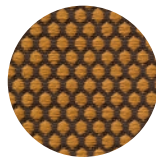

Mostarda
Mustard

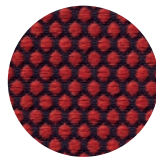

Ciliegia
Cherry

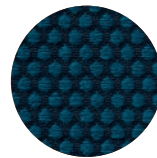

Blu Pavone
Peacock

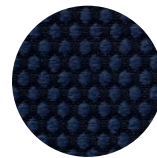

Blu Notte
Midnight Blue

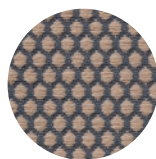

Latte
Steamed Milk

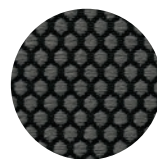

Antracite
Anthracite

Torrilana Rakam



Bacca
Berry

FINITURE | FINISHES

TESSUTI | FABRICS

D

Cloud



Panna
Cream



Noce
Walnut

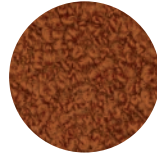

Nocciola
Hazelnut

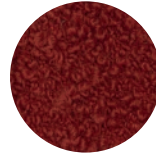

Bordeaux

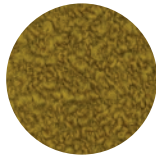

Senape
Mustard

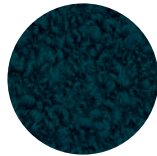

Petrolio
Blue-Green

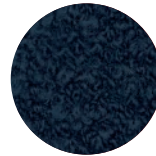

Blu Notte
Night Blue

Maharam Merit

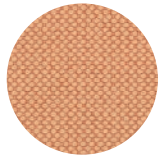

Salmone
Salmon

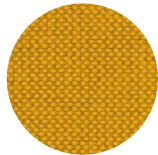

Ciallo
Yellow

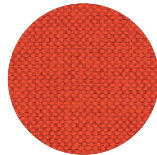

Rosso Corallo
Coral Red

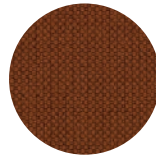

Marrone
Brown

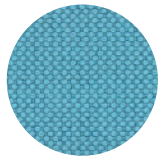

Celeste
Sky Blue

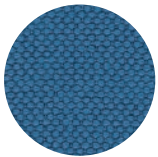

Blu Cobalto
Cobalt Blue

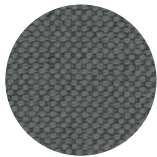

Grigio
Grey

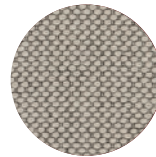

Sale e Pepe
Salt and Pepper

TESSUTI | FABRICS

D

Rohi Sera

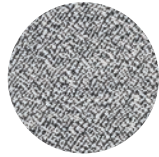

Pepper

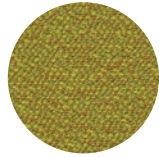

Tivoli

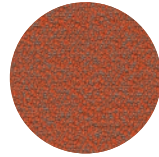

Glow

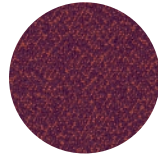

Berry

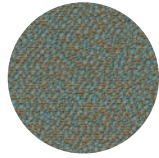

Mirage

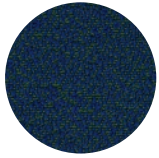

Mare

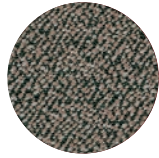

Walnut



Rosewood

Rohi Mica

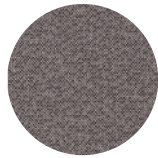

Pepper

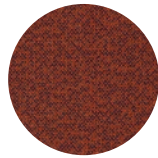

Indio

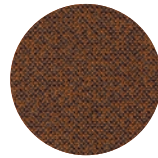

Amber

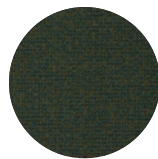

Jungle

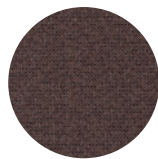

Mud

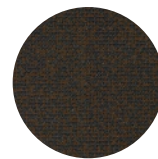

Secret

FINITURE | FINISHES

TESSUTI | FABRICS

E

Kvadrat Steelcut Trio 3

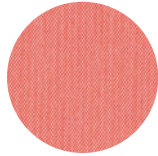

Arancia Rossa
Red Orange



Pavone
Peacock

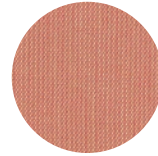

Pesca
Peach



Sale e Pepe
Salt and Pepper



Elettricità
Electricity