

Choose the language

English

Italiano

Deutsch

Français

Español

Nori Sizes

Depth 90 cm Depth 35 3/8"

90	139 cm 54 6/8"	→ Fenix-NTM® → DEKTON®
	139/176/214 cm 54 6/8/69 2/8/84 2/8"	→ Fenix-NTM® → DEKTON®
	166 cm 65 3/8"	→ Fenix-NTM® → DEKTON®
	166/203/241/278 cm 65 3/8/79 7/8/94 7/8/109 4/8"	→ Fenix-NTM®
	166/203/241 cm 65 3/8/79 7/8/94 7/8"	→ DEKTON®
	189 cm 74 3/8"	→ Fenix-NTM® → DEKTON®
	189/226/263 cm 74 3/8/89/103 4/8" *	→ Fenix-NTM®
	189/226/263 cm 74 3/8/89/103 4/8"	→ DEKTON®
	209 cm 82 2/8"	→ Fenix-NTM®
	209/246/283 cm 82 2/8/96 7/8/111 3/8" *	→ Fenix-NTM®

Depth 90 cm Depth 35 3/8"

90	159 cm 62 5/8"	→ Teak
	159/199/239 cm 62 5/8/78 3/8/94 1/8"	→ Teak
	179 cm 70 4/8"	→ Teak
	179/219/259 cm 70 4/8/86 2/8/102"	→ Teak
	199 cm 78 3/8"	→ Teak
	199/239/279 cm 78 3/8/94 1/8/109 7/8"	→ Teak
	219 cm 86 2/8"	→ Teak
	219/259/299 cm 86 2/8/102/117 6/8"	→ Teak
	259 cm 102"	→ Teak
	298 cm 117 6/8"	→ Teak

Depth 100 cm Depth 39 3/8"

100	166 cm 65 3/8"	→ Fenix-NTM® → DEKTON®
	166/213/260 cm 65 3/8/83 7/8/102 3/8" *	→ Fenix-NTM®
	166/203/240 cm 65 3/8/79 7/8/94 4/8"	→ DEKTON®
	189 cm 74 3/8"	→ Fenix-NTM® → DEKTON®
	189/236/283 cm 74 3/8/92 7/8/111 3/8" *	→ Fenix-NTM®
	189/226/263 cm 74 3/8/89/103 4/8"	→ DEKTON®
	209 cm 82 2/8"	→ Fenix-NTM®
	209/256/303 cm 82 2/8/100 6/8/119 2/8" *	→ Fenix-NTM®
	229 cm 90 1/8"	→ DEKTON®
	269 cm 105 7/8"	→ DEKTON®

* = 3rd additional extension (on request)

Tops

Depth 100 cm

Depth 39 3/8"

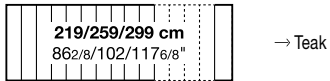
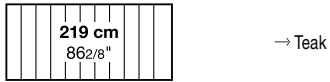
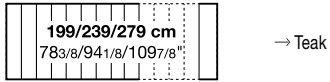
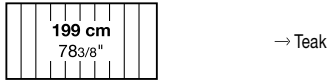
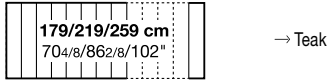
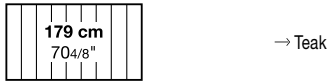

Depth 124 cm

Depth 48 7/8"

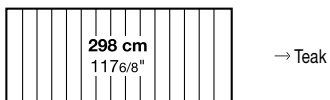
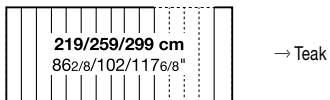
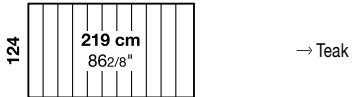

Fenix-NTM® black edge 10 mm thick

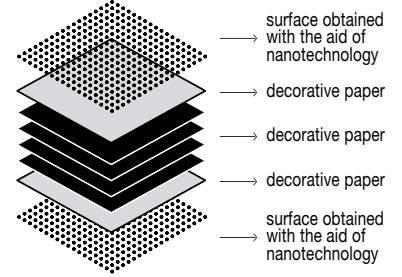
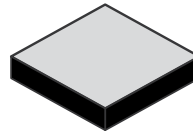

DEKTON® by Cosentino 8 mm thick

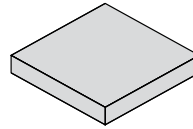

Dekton is a sophisticated mix of raw materials used to create glass, latest generation ceramic and top-quality quartz surfaces.

Teak Thick 20 mm

Over time, untreated teak will acquire a typical silvery colour characteristic of this wood finish when exposed to the open air. This aesthetic process does not affect the quality or the resistance of the material.

For regular cleaning operations, use a detergent for outdoor furniture made of wood, or simply use a soft brush and water.

ICADECK (water-based oil) can be applied to prevent oxidation of the surface of the new product.

To remove the grey patina caused by oxidation and restore the original colour of the teak, use **CLEANDECK** (anti-grey detergent). Treatment with **CLEANDECK** must be followed by washing and applying **ICADECK** to a dry surface.

Do not use a high-pressure cleaner, as it would damage the wood surface and fibres. To remove surface scratches, you can use sandpaper or a manual sander.

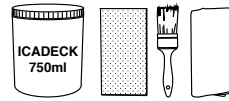
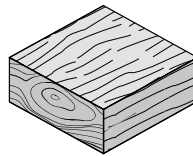

ICADECK KIT
ICADECK + abrasive sponge + brush + cloth



ICADECK



CLEANDECK

Code	Price in EURO	Packs	Vol.³	Kg
02KITOUT01 ICADECK KIT (water-based oil)		1	0,01	2
02KITOUT02 ICADECK (water-based oil)		1	0,01	1,5
02KITOUT03 CLEANDECK (anti-grey detergent)		1	0,01	1,5

Nori Fenix-NTM®

Extensible/Fixed - Depth 90 cm.

Leg finish:

Anodised aluminium

White lacquered aluminium (similar to RAL 9016)

"Fenix-NTM® London grey" lacquered aluminium (similar to RAL Design0805005)

"Fenix-NTM® Bromo grey" lacquered aluminium (similar to RAL 7012)

Black lacquered aluminium (similar to RAL 9004)

Olive green painted aluminium (colour ref. "Olive green PO08 polyurethane")

Finish of top/extensions:

Fenix-NTM® black edge (Kos white 0032, London grey 0718, Bromo grey 0724, Ingo black 0720)

→ For tables with codes marked with an asterisk (*), a third extension can be added to further increase the length.

→ Important: measurements or finishes marked with (I) require longer production times, about 6 weeks from the order date.

→ Tables that extend to more than 250 cm have a top that slightly bends, which complies with accepted quality standards.

→ Reinforced packaging, see inside of cover.

→ "Casper" protective cover, see page 74.

Extensible (▶)

Code	Length (L)	Depth	Legs	Top	Price in EURO	Packs	Vol. ³	Kg
01NOR03	139-176-214	90	aluminium	Fenix black edge		3	0,41	71
			lacquered	Fenix black edge				
01NOR04	166-203-241-278 <small>3rd standard extension</small>	90	aluminium	Fenix black edge		4	0,5	81
			lacquered	Fenix black edge				
01NOR08*	189-226-263	90	aluminium	Fenix black edge		3	0,51	82
			lacquered	Fenix black edge				
01NOR30*	209-246-283	90	aluminium	Fenix black edge (I)		3	0,55	88
			lacquered	Fenix black edge (I)				

(* 3rd additional extension

Code	Length (L)	Extension	Price in EURO	Packs	Vol. ³	Kg
50SUS02A	37,5	Fenix black edge		1	0,025	6,5

Fixed (II)

Code	Length (L)	Depth	Legs	Top	Price in EURO	Packs	Vol. ³	Kg
01NOR03F	139	90	aluminium	Fenix black edge		1	0,36	46
			lacquered	Fenix black edge				
01NOR04F	166	90	aluminium	Fenix black edge		1	0,42	52
			lacquered	Fenix black edge				
01NOR53F	189	90	aluminium	Fenix black edge		1	0,46	57
			lacquered	Fenix black edge				
01NOR30F	209	90	aluminium	Fenix black edge (I)		1	0,5	62
			lacquered	Fenix black edge (I)				

Optionals

Code			Price in EURO	Packs	Vol. ³	Kg
02GTA02		legs height cut to size		-	-	-

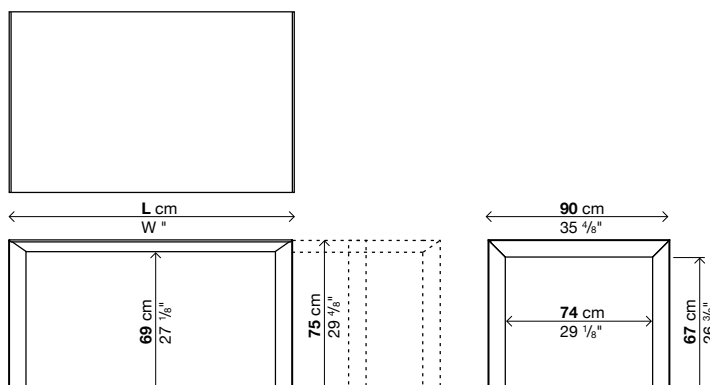

Nori Fenix-NTM®

Extensible/Fixed - Depth 100 cm.

Leg finish:

Anodised aluminium
 White lacquered aluminium (similar to RAL 9016)
 "Fenix-NTM® London grey" lacquered aluminium (similar to RAL Design0805005)
 "Fenix-NTM® Bromo grey" lacquered aluminium (similar to RAL 7012)
 Black lacquered aluminium (similar to RAL 9004)
 Olive green painted aluminium (colour ref. "Olive green PO08 polyurethane")

Finish of top/extensions:

Fenix-NTM® black edge (Kos white 0032, London grey 0718, Bromo grey 0724, Ingo black 0720)

→ For tables with codes marked with an asterisk (*), a third extension can be added to further increase the length.

→ Tables that extend to more than 250 cm have a top that slightly bends, which complies with accepted quality standards.

→ Reinforced packaging, see inside of cover.

→ "Casper" protective cover, see page 74.

Extensible (►)

Code	Length (L)	Depth	Legs	Top	Price in EURO	Packs	Vol. ³	Kg
01NOR05*	166-213-260	100	aluminium	Fenix black edge		3	0,52	85
			lacquered	Fenix black edge				
01NOR09*	189-236-283	100	aluminium	Fenix black edge		3	0,57	92
			lacquered	Fenix black edge				
01NOR06*	209-256-303	100	aluminium	Fenix black edge		3	0,62	98
			lacquered	Fenix black edge				

(*) 3rd additional extension

Code	Length (L)	Extension	Price in EURO	Packs	Vol. ³	Kg
50SUS06A	33	Fenix black edge		1	0,035	6

Fixed (II)

Code	Length (L)	Depth	Legs	Top	Price in EURO	Packs	Vol. ³	Kg
01NOR05F	166	100	aluminium	Fenix black edge		1	0,45	56
			lacquered	Fenix black edge				
01NOR07F	189	100	aluminium	Fenix black edge		1	0,5	62
			lacquered	Fenix black edge				
01NOR06F	209	100	aluminium	Fenix black edge		1	0,55	67
			lacquered	Fenix black edge				

Optionals

Code			Price in EURO	Packs	Vol. ³	Kg
02GTA02		legs height cut to size		-	-	-

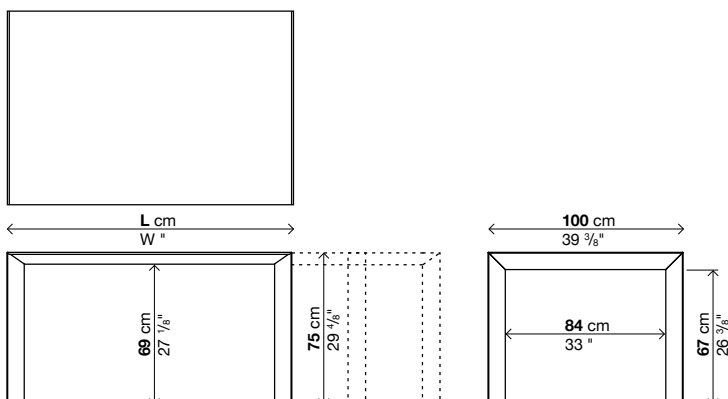

Nori DEKTON® by Cosentino

Extensible/Fixed - Depth 90/100 cm.

Leg finish:

Anodised aluminium
 White lacquered aluminium (similar to RAL 9016)
 "Ventus grey" lacquered aluminium
 Olive green painted aluminium (colour ref. "Olive green PO08 polyurethane")

Finish of top:

DEKTON® Zenith white
 DEKTON® Ventus grey
 DEKTON® Aura (digital marble)

Finish of extensions:

White lacquered aluminium (similar to RAL 9016)
 "Ventus grey" lacquered aluminium

→ Important: the grain pattern reproduced on the surface of DEKTON® Aura (digital marble) tops is random, a special feature that makes each top unique and original. This characteristic implies possible differences to samples that are not to be considered imperfections or irregularities. Due to their random nature, uniform grain patterns cannot be requested.

→ Important: sizes and finishes marked with (!) require longer production lead time, about 6 weeks from the date of the order.

→ Tables that extend to more than 250 cm have a top that slightly bends, which complies with accepted quality standards.

→ Reinforced packaging, see inside of cover.

→ "Casper" protective cover, see page 74.

Extensible (►)

Code	Length (L)	Depth	Legs	Top	Price in EURO	Packs	Vol.³	Kg
01NOR03	139-176-214	90	aluminium	DEKTON (!)		3	0,41	89
			lacquered	DEKTON (!)				
01NOR04	166-203-241	90	aluminium	DEKTON (!)		3	0,5	102
			lacquered	DEKTON (!)				
01NOR08	189-226-263	90	aluminium	DEKTON (!)		3	0,51	105
			lacquered	DEKTON (!)				
01NOR05	166-203-240	100	aluminium	DEKTON (!)		3	0,52	108
			lacquered	DEKTON (!)				
01NOR09	189-226-263	100	aluminium	DEKTON (!)		3	0,57	118
			lacquered	DEKTON (!)				

Fixed (||)

Code	Length (L)	Depth	Legs	Top	Price in EURO	Packs	Vol.³	Kg
01NOR03F	139	90	aluminium lacquered	DEKTON (!) DEKTON (!)		1	0,36	60
01NOR04F	166	90	aluminium lacquered	DEKTON (!) DEKTON (!)		1	0,42	69
01NOR53F	189	90	aluminium lacquered	DEKTON (!) DEKTON (!)		1	0,46	76
01NOR05F	166	100	aluminium lacquered	DEKTON (!) DEKTON (!)		1	0,45	74
01NOR07F	189	100	aluminium lacquered	DEKTON (!) DEKTON (!)		1	0,5	83
01NOR08F	229	100	aluminium lacquered	DEKTON (!) DEKTON (!)		1	0,6	97
01NOR69F	269	100	aluminium lacquered	DEKTON (!) DEKTON (!)		1	0,69	115

Optionals

Code	Price in EURO	coll.	m²	Kg
02GTA02		✂	legs height cut to size	-

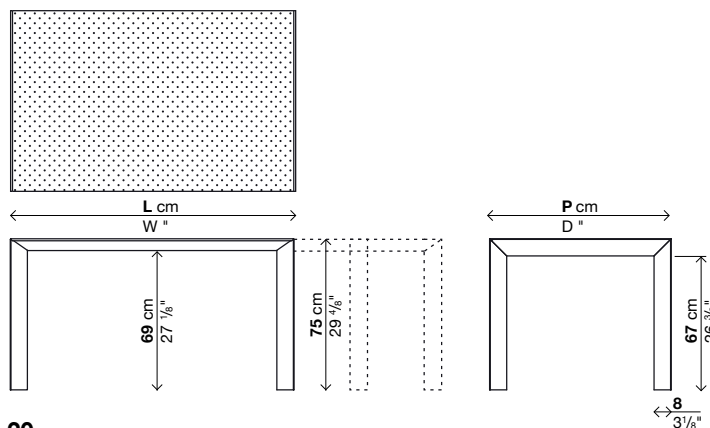

HIGHLY UV RESISTANT



RESISTANT TO ABRASION



RESISTANT TO STAIN



MAXIMUM RESISTANCE TO FIRE AND HEAT



LOW WATER ABSORPTION



HIGH MECHANICAL RESISTANCE



COLOUR STABILITY



DIMENSIONAL STABILITY



FIREPROOF MATERIAL

Nori

Legenda dimensioni

Prof. 90 cm
Depth 35 3/8"

90	139 cm 54 6/8"	→ Fenix-NTM® → DEKTON®
	139/176/214 cm 54 6/8/69 2/8/84 2/8"	→ Fenix-NTM® → DEKTON®
	166 cm 65 3/8"	→ Fenix-NTM® → DEKTON®
	166/203/241/278 cm 65 3/8/79 7/8/94 7/8/109 4/8"	→ Fenix-NTM®
	166/203/241 cm 65 3/8/79 7/8/94 7/8"	→ DEKTON®
	189 cm 74 3/8"	→ Fenix-NTM® → DEKTON®
	189/226/263 cm 74 3/8/89/103 4/8" *	→ Fenix-NTM®
	189/226/263 cm 74 3/8/89/103 4/8"	→ DEKTON®
	209 cm 82 2/8"	→ Fenix-NTM®
	209/246/283 cm 82 2/8/96 7/8/111 3/8" *	→ Fenix-NTM®

Prof. 90 cm
Depth 35 3/8"

90	159 cm 62 5/8"	→ Teak
	159/199/239 cm 62 5/8/78 3/8/94 1/8"	→ Teak
	179 cm 70 4/8"	→ Teak
	179/219/259 cm 70 4/8/86 2/8/102"	→ Teak
	199 cm 78 3/8"	→ Teak
	199/239/279 cm 78 3/8/94 1/8/109 7/8"	→ Teak
	219 cm 86 2/8"	→ Teak
	219/259/299 cm 86 2/8/102/117 6/8"	→ Teak
	259 cm 102"	→ Teak
	298 cm 117 6/8"	→ Teak

Prof. 100 cm
Depth 39 3/8"

100	166 cm 65 3/8"	→ Fenix-NTM® → DEKTON®
	166/213/260 cm 65 3/8/83 7/8/102 3/8" *	→ Fenix-NTM®
	166/203/240 cm 65 3/8/79 7/8/94 4/8"	→ DEKTON®
	189 cm 74 3/8"	→ Fenix-NTM® → DEKTON®
	189/236/283 cm 74 3/8/92 7/8/111 3/8" *	→ Fenix-NTM®
	189/226/263 cm 74 3/8/89/103 4/8"	→ DEKTON®
	209 cm 82 2/8"	→ Fenix-NTM®
	209/256/303 cm 82 2/8/100 6/8/119 2/8" *	→ Fenix-NTM®
	229 cm 90 1/8"	→ DEKTON®
	269 cm 105 7/8"	→ DEKTON®

* = 3ª prolunga aggiuntiva (a richiesta)

Piani

Prof. 100 cm Depth 39 3/8"

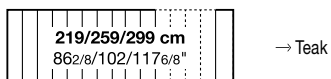
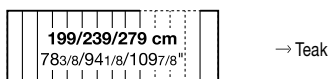
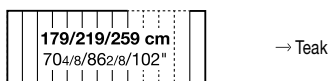

Prof. 124 cm Depth 48 7/8"

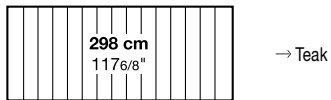
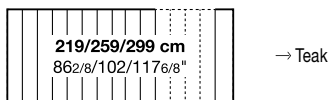

Fenix-NTM® bordo nero Sp. 10 mm

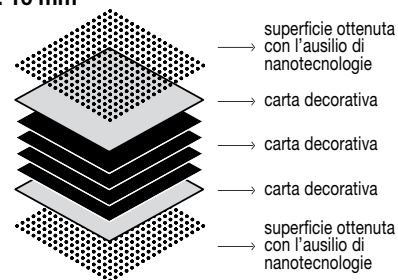
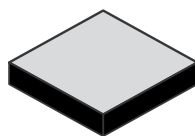

DEKTON® by Cosentino Sp. 8 mm

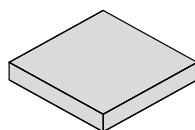

Dekton è una sofisticata miscela di materie prime utilizzate per la creazione di vetro, ceramica di ultima generazione e superfici in quarzo di altissima qualità

Teak Sp. 20 mm

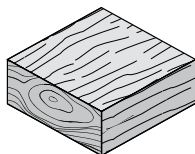

Con il passare del tempo, il teak non trattato otterrà il tipico colore argenteo che caratterizza questa essenza all'aria aperta. Questo processo estetico non ha alcuna influenza sulla qualità o la resistenza del materiale.

Per la normale pulizia del teak si può utilizzare un detergente per mobili in legno da esterni, oppure semplicemente una spazzola a setole morbide e dell'acqua.

Per evitare l'ossidazione superficiale del prodotto nuovo è possibile applicare **ICADECK** (olio all'acqua).

Per rimuovere la patina grigia dovuta all'ossidazione e ripristinare il colore originale del teak, utilizzare **CLEANDECK** (detergente antigrigio). Il trattamento con **CLEANDECK** deve essere seguito da un lavaggio e dall'applicazione di **ICADECK** su superficie asciutta.

Non usare l'idropulitrice che danneggerebbe la superficie e le fibre del legno. Per eliminare graffi superficiali si può usare della carta abrasiva oppure una levigatrice a mano.

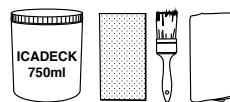

KIT ICADECK

ICADECK + spugna abrasiva + pennello + panno



ICADECK



CLEANDECK

Codice	Prezzi EURO	coll.	m ³	Kg
02KITOUT01 KIT ICADECK (olio all'acqua)		1	0,01	2
02KITOUT02 ICADECK (olio all'acqua)		1	0,01	1,5
02KITOUT03 CLEANDECK (detergente antigrigio)		1	0,01	1,5

Nori Fenix-NTM®

Allungabile/Fisso - Prof. 90 cm.

Finitura gambe:

Alluminio anodizzato

Alluminio verniciato bianco (simile al Ral 9016)

Alluminio verniciato "Fenix-NTM® grigio Londra" (simile al Ral Design0805005)

Alluminio verniciato "Fenix-NTM® grigio Bromo" (simile al Ral 7012)

Alluminio verniciato nero (simile al Ral 9004)

Alluminio verniciato verde oliva (rif. colore "Poliuretano verde oliva PO08")

Finitura piano/prolunghe:

Fenix-NTM® bordo nero (bianco Kos 0032, grigio Londra 0718, grigio Bromo 0724, nero Ingo 0720)

→ Nei tavoli con i codici contrassegnati con l'asterisco (*) c'è la possibilità di aggiungere la terza prolunga per aumentare ulteriormente l'allungo.

→ Attenzione: le misure o le finiture contrassegnate con (!) hanno tempi di produzione più lunghi, circa 6 settimane dalla data dell'ordine.

→ I tavoli che in estensione superano i 250 cm presentano una leggera flessione del piano, che rientra negli standard di qualità accettati.

→ Imballi rinforzati vedi interno di copertina.

→ Copertura protettiva "Casper" vedi pag. 74.

Allungabile (▶)

Codice	Lunghezza (L)	Prof.	Gambe	Piano	Prezzi EURO	coll.	m ²	Kg
01NOR03	139-176-214	90	alluminio	Fenix bordo nero		3	0,41	71
			verniciato	Fenix bordo nero				
01NOR04	166-203-241-278 3 ^a prolunga di serie	90	alluminio	Fenix bordo nero		4	0,5	81
			verniciato	Fenix bordo nero				
01NOR08*	189-226-263	90	alluminio	Fenix bordo nero		3	0,51	82
			verniciato	Fenix bordo nero				
01NOR30*	209-246-283	90	alluminio	Fenix bordo nero (!)		3	0,55	88
			verniciato	Fenix bordo nero (!)				

(*) 3^a prolunga aggiuntiva

Codice	Lunghezza (L)	Prolunga	Prezzi EURO	coll.	m ²	Kg
50SUS02A	37,5	Fenix bordo nero		1	0,025	6,5

Fisso (II)

Codice	Lunghezza (L)	Prof.	Gambe	Piano	Prezzi EURO	coll.	m ²	Kg
01NOR03F	139	90	alluminio	Fenix bordo nero		1	0,36	46
			verniciato	Fenix bordo nero				
01NOR04F	166	90	alluminio	Fenix bordo nero		1	0,42	52
			verniciato	Fenix bordo nero				
01NOR53F	189	90	alluminio	Fenix bordo nero		1	0,46	57
			verniciato	Fenix bordo nero				
01NOR30F	209	90	alluminio	Fenix bordo nero (!)		1	0,5	62
			verniciato	Fenix bordo nero (!)				

Optionals

Codice		Prezzi EURO	coll.	m ²	Kg
02GTA02	 taglio gambe a misura	-	-	-	-

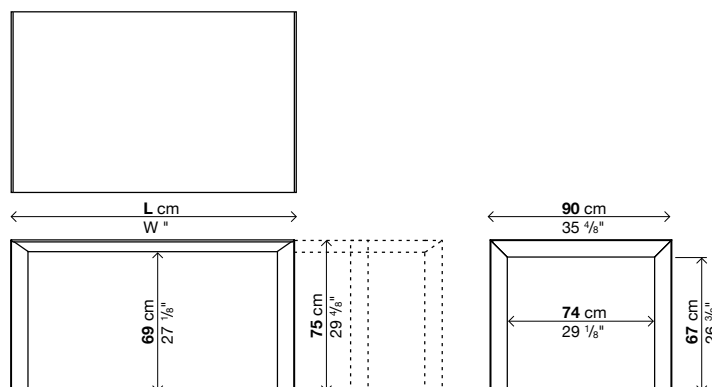

Nori Fenix-NTM®

Allungabile/Fisso - Prof. 100 cm.

Finitura gambe:

Alluminio anodizzato

Alluminio verniciato bianco (simile al Ral 9016)

Alluminio verniciato "Fenix-NTM® grigio Londra" (simile al Ral Design0805005)

Alluminio verniciato "Fenix-NTM® grigio Bromo" (simile al Ral 7012)

Alluminio verniciato nero (simile al Ral 9004)

Alluminio verniciato verde oliva (rif. colore "Poliuretano verde oliva PO08")

Finitura piano/prolunghe:

Fenix-NTM® bordo nero (bianco Kos 0032, grigio Londra 0718, grigio

Bromo 0724, nero Ingo 0720)

→ Nei tavoli con i codici contrassegnati con l'asterisco (*) c'è la possibilità di aggiungere la terza prolunga per aumentare ulteriormente l'allungo.

→ I tavoli che in estensione superano i 250 cm presentano una leggera flessione del piano, che rientra negli standard di qualità accettati.

→ Imballi rinforzati vedi interno di copertina.

→ Copertura protettiva "Casper" vedi pag. 74.

Allungabile (►)

Codice	Lunghezza (L)	Prof.	Gambe	Piano	Prezzi EURO	colli	m ³	Kg
01NOR05*	166-213-260	100	alluminio	Fenix bordo nero		3	0,52	85
			verniciato	Fenix bordo nero				
01NOR09*	189-236-283	100	alluminio	Fenix bordo nero		3	0,57	92
			verniciato	Fenix bordo nero				
01NOR06*	209-256-303	100	alluminio	Fenix bordo nero		3	0,62	98
			verniciato	Fenix bordo nero				

(*) 3^a prolunga aggiuntiva

Codice	Lunghezza (L)	Prolunga	Prezzi EURO	colli	m ³	Kg
50SUS06A	33	Fenix bordo nero		1	0,035	6

Fisso (II)

Codice	Lunghezza (L)	Prof.	Gambe	Piano	Prezzi EURO	colli	m ³	Kg
01NOR05F	166	100	alluminio	Fenix bordo nero		1	0,45	56
			verniciato	Fenix bordo nero				
01NOR07F	189	100	alluminio	Fenix bordo nero		1	0,5	62
			verniciato	Fenix bordo nero				
01NOR06F	209	100	alluminio	Fenix bordo nero		1	0,55	67
			verniciato	Fenix bordo nero				

Optionals

Codice			Prezzi EURO	colli	m ³	Kg
02GTA02		taglio gambe a misura		-	-	-

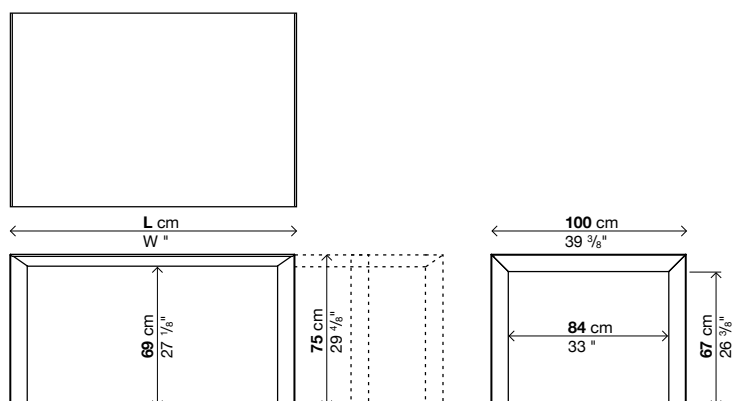

Nori DEKTON® by Cosentino

Allungabile/Fisso - Prof. 90/100 cm.

Finitura gambe:

Alluminio anodizzato

Alluminio verniciato bianco (simile al Ral 9016)

Alluminio verniciato "grigio Ventus"

Alluminio verniciato verde oliva (rif. colore "Poliuretano verde oliva PO08")

Finitura piano:

DEKTON® bianco Zenith

DEKTON® grigio Ventus

DEKTON® Aura (marmo digitale)

Finitura prolunghe:

Alluminio verniciato bianco (simile al Ral 9016)

Alluminio verniciato "grigio Ventus"

→ *Attenzione: le venature riprodotte sulla superficie dei piani in DEKTON® Aura (marmo digitale) sono disposte in modo casuale, peculiarità che rende ciascun piano unico e non ripetibile. Questa caratteristica implica possibili differenze rispetto ai campioni, non contestabili quali imperfezioni o anomalie. In virtù della casualità della loro disposizione, non è possibile avere su richiesta venature più o meno omogenee.*

→ *Attenzione: le misure o le finiture contrassegnate con (!) hanno tempi di produzione più lunghi, circa 6 settimane dalla data dell'ordine.*

→ *I tavoli che in estensione superano i 250 cm presentano una leggera flessione del piano, che rientra negli standard di qualità accettati.*

→ *Imballi rinforzati vedi interno di copertina.*

→ **Copertura protettiva "Casper" vedi pag. 74.**

Allungabile (►)

Codice	Lunghezza (L)	Prof.	Gambe	Piano	Prezzi EURO	coll. m ²	Kg
01NOR03	139-176-214	90	alluminio	DEKTON (!)		3	0,41 - 89
			verniciato	DEKTON (!)			
01NOR04	166-203-241	90	alluminio	DEKTON (!)		3	0,5 - 102
			verniciato	DEKTON (!)			
01NOR08	189-226-263	90	alluminio	DEKTON (!)		3	0,51 - 105
			verniciato	DEKTON (!)			
01NOR05	166-203-240	100	alluminio	DEKTON (!)		3	0,52 - 108
			verniciato	DEKTON (!)			
01NOR09	189-226-263	100	alluminio	DEKTON (!)		3	0,57 - 118
			verniciato	DEKTON (!)			

Fisso (II)

Codice	Lunghezza (L)	Prof.	Gambe	Piano	Prezzi EURO	coll. m ²	Kg
01NOR03F	139	90	alluminio	DEKTON (!)		1	0,36 - 60
			verniciato	DEKTON (!)			
01NOR04F	166	90	alluminio	DEKTON (!)		1	0,42 - 69
			verniciato	DEKTON (!)			
01NOR53F	189	90	alluminio	DEKTON (!)		1	0,46 - 76
			verniciato	DEKTON (!)			
01NOR05F	166	100	alluminio	DEKTON (!)		1	0,45 - 74
			verniciato	DEKTON (!)			
01NOR07F	189	100	alluminio	DEKTON (!)		1	0,5 - 83
			verniciato	DEKTON (!)			
01NOR08F	229	100	alluminio	DEKTON (!)		1	0,6 - 97
			verniciato	DEKTON (!)			
01NOR69F	269	100	alluminio	DEKTON (!)		1	0,69 - 115
			verniciato	DEKTON (!)			

Optionals

Codice		Prezzi EURO	coll. m ²	Kg
02GTA02	 taglio gambe a misura	-	-	-

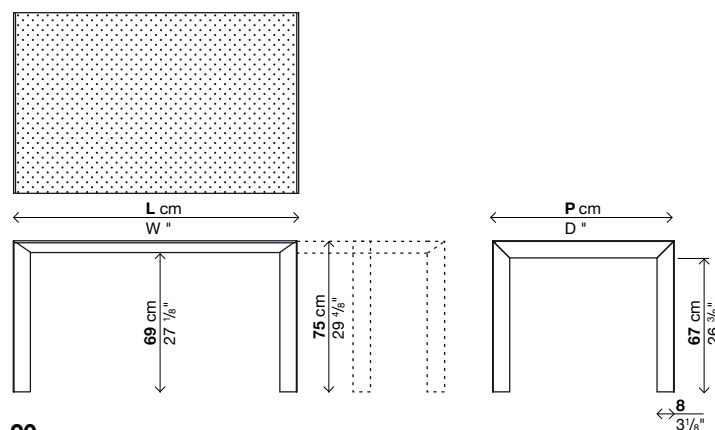

DEKTON®
by COSENTINO



HIGHLY UV RESISTANT



RESISTANT TO ABRASION



RESISTANT TO STAIN



MAXIMUM RESISTANCE TO FIRE AND HEAT



LOW WATER ABSORPTION



HIGH MECHANICAL RESISTANCE



COLOUR STABILITY



DIMENSIONAL STABILITY



FIREPROOF MATERIAL

Nori

Größenübersicht

Breite 90 cm
Breite 35³/₈"

90	139 cm 54 ⁶ / ₈ "	→ Fenix-NTM® → DEKTON®
	139/176/214 cm 54 ⁶ / ₈ /69 ² / ₈ /84 ² / ₈ "	→ Fenix-NTM® → DEKTON®
	166 cm 65 ³ / ₈ "	→ Fenix-NTM® → DEKTON®
	166/203/241/278 cm 65 ³ / ₈ /79 ⁷ / ₈ /94 ⁷ / ₈ /109 ⁴ / ₈ "	→ Fenix-NTM®
	166/203/241 cm 65 ³ / ₈ /79 ⁷ / ₈ /94 ⁷ / ₈ "	→ DEKTON®
	189 cm 74 ³ / ₈ "	→ Fenix-NTM® → DEKTON®
	189/226/263 cm 74 ³ / ₈ /89/103 ⁴ / ₈ " *	→ Fenix-NTM®
	189/226/263 cm 74 ³ / ₈ /89/103 ⁴ / ₈ "	→ DEKTON®
	209 cm 82 ² / ₈ "	→ Fenix-NTM®
	209/246/283 cm 82 ² / ₈ /96 ⁷ / ₈ /111 ³ / ₈ " *	→ Fenix-NTM®

Breite 90 cm
Breite 35³/₈"

90	159 cm 62 ⁵ / ₈ "	→ Teak
	159/199/239 cm 62 ⁵ / ₈ /78 ³ / ₈ /94 ¹ / ₈ "	→ Teak
	179 cm 70 ⁴ / ₈ "	→ Teak
	179/219/259 cm 70 ⁴ / ₈ /86 ² / ₈ /102"	→ Teak
	199 cm 78 ³ / ₈ "	→ Teak
	199/239/279 cm 78 ³ / ₈ /94 ¹ / ₈ /109 ⁷ / ₈ "	→ Teak
	219 cm 86 ² / ₈ "	→ Teak
	219/259/299 cm 86 ² / ₈ /102/117 ⁶ / ₈ "	→ Teak
	259 cm 102"	→ Teak
	298 cm 117 ⁶ / ₈ "	→ Teak

Breite 100 cm
Breite 39³/₈"

100	166 cm 65 ³ / ₈ "	→ Fenix-NTM® → DEKTON®
	166/213/260 cm 65 ³ / ₈ /83 ⁷ / ₈ /102 ³ / ₈ " *	→ Fenix-NTM®
	166/203/240 cm 65 ³ / ₈ /79 ⁷ / ₈ /94 ⁴ / ₈ "	→ DEKTON®
	189 cm 74 ³ / ₈ "	→ Fenix-NTM® → DEKTON®
	189/236/283 cm 74 ³ / ₈ /92 ⁷ / ₈ /111 ³ / ₈ " *	→ Fenix-NTM®
	189/226/263 cm 74 ³ / ₈ /89/103 ⁴ / ₈ "	→ DEKTON®
	209 cm 82 ² / ₈ "	→ Fenix-NTM®
	209/256/303 cm 82 ² / ₈ /100 ⁶ / ₈ /119 ² / ₈ " *	→ Fenix-NTM®
	229 cm 90 ¹ / ₈ "	→ DEKTON®
	269 cm 105 ⁷ / ₈ "	→ DEKTON®

* = 3. zusätzliche Verlängerung (auf Anfrage)

Platten

Breite 100 cm

Breite 39 3/8"

100	100 cm 39 3/8"	→ Teak
	179 cm 70 4/8"	→ Teak
	179/219/259 cm 70 4/8/86 2/8/102"	→ Teak
	199 cm 78 3/8"	→ Teak
	199/239/279 cm 78 3/8/94 1/8/109 7/8"	→ Teak
	219 cm 86 2/8"	→ Teak
	219/259/299 cm 86 2/8/102/117 6/8"	→ Teak
	259 cm 102"	→ Teak

Breite 124 cm

Breite 48 7/8"

124	219 cm 86 2/8"	→ Teak
	219/259/299 cm 86 2/8/102/117 6/8"	→ Teak
	259 cm 102"	→ Teak
	298 cm 117 6/8"	→ Teak

Fenix-NTM® schwarze Kante St. 10 mm

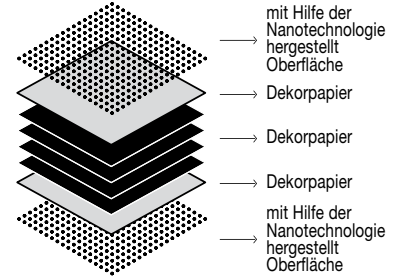
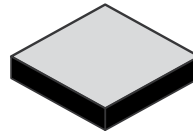

DEKTON® by Cosentino St. 8 mm

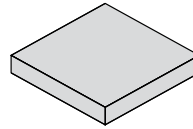

Dekton ist ein hoch entwickeltes Rohstoffgemisch, das für die Erzeugung von Glas, Keramik der letzten Generation und Quarzoberflächen mit höchster Qualität eingesetzt wird.

Teak St. 20 mm

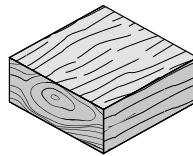

Im Laufe der Zeit erhält nicht behandeltes Teakholz jene typische silbergraue Patina, die dieses Holz im Freien auszeichnet. Dieser das Aussehen betreffende Prozess hat keinerlei Auswirkungen auf die Qualität oder die Widerstandsfähigkeit des Materials.

Für die normale Reinigung von Teakholz können ein Reinigungsmittel für Gartenmöbel aus Holz oder einfach eine weiche Bürste und Wasser eingesetzt werden.

Um eine oberflächliche Oxidation des neuen Produkts zu verhindern, kann eine Schicht **ICADECK** (Öl auf Wasserbasis) aufgetragen werden.

Um die durch Oxidierung entstandene graue Patina zu entfernen und die ursprüngliche Farbe des Teakholzes wieder herzustellen, wird die Verwendung von **CLEANDECK** (Anti-Grau-Reinigungsmittel) empfohlen. Nach der Reinigung mit **CLEANDECK** muss das Holz gewaschen und die trockene Oberfläche mit einer Schicht **ICADECK** behandelt werden.

Verwenden Sie keinen Hochdruckreiniger, da dieser die Oberfläche und die Holzfasern beschädigen würde. Leichte Kratzspuren lassen sich mit Schleifpapier oder einem Handschleifgerät entfernen.

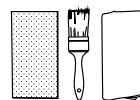

PFLEGESET ICADECK
ICADECK + Reibschwamm + Pinsel + Tuch

ICADECK

CLEANDECK

Art.-Nr.		Preis in EURO	Kolli	V.m ³	Kg
02KITOUT01	PFLEGESET ICADECK (Öl auf Wasserbasis)		1	0,01	2
02KITOUT02	ICADECK (Öl auf Wasserbasis)		1	0,01	1,5
02KITOUT03	CLEANDECK (Anti-Grau-Reinigungsmittel)		1	0,01	1,5

Nori Fenix-NTM®

Erweiterbar/Fixmaße - Breite 90 cm.

Ausführung der Beine:

Eloxiertes Aluminium

Weiß lackiertes Aluminium (farbähnlich wie Ral 9016)

“Fenix-NTM® Grau London” lackiertes Aluminium (farbähnlich wie Ral Design0805005)

“Fenix-NTM® Grau Bromo” lackiertes Aluminium (farbähnlich wie Ral 7012)

Schwarz lackiertes Aluminium (farbähnlich wie Ral 9004)

Olivgrün lackiertes Aluminium (farbähnlich wie “Polyurethan Olivgrün PO08”)

Ausführung der Tischplatte/Verlängerungen:

Fenix-NTM® mit schwarzer Kante (Weiß Kos 0032, Grau London 0718,

Grau Bromo 0724, Schwarz Ingo 0720)

→ Bei den Tischen, deren Artikelnummern mit Sternchen (*) markiert sind, ist das Hinzufügen einer dritten Verlängerung möglich, wodurch der Tisch noch größer wird.

→ Achtung: Die mit (!) gekennzeichneten Maße oder Ausführungen haben eine längere Lieferzeit: zirka 6 Wochen ab Auftragsdatum.

→ Jene Tische, die im ausgezogenen Zustand eine Länge von 250 cm überschreiten, weisen eine leichte Biegung der Platte auf, die jedoch innerhalb der festgelegten qualitativen Standards liegt.

→ Für verstärkte Verpackungen siehe Innenseite des Umschlags.

→ **Schutzhülle “Casper” siehe Seite 74.**

Erweiterbar (▶)

Art.-Nr.	Länge (L)	Breite	Beine	Platte	Preis in EURO	Koll.	V.m³	Kg
01NOR03	139-176-214	90	Aluminium lacquered	Fenix schwarze Kante Fenix schwarze Kante		3	0,41	71
01NOR04	166-203-241-278 <i>dritte Verlängerung standard</i>	90	Aluminium lacquered	Fenix schwarze Kante Fenix schwarze Kante		4	0,5	81
01NOR08*	189-226-263	90	Aluminium lacquered	Fenix schwarze Kante Fenix schwarze Kante		3	0,51	82
01NOR30*	209-246-283	90	Aluminium lacquered	Fenix schwarze Kante (!) Fenix schwarze Kante (!)		3	0,55	88

(*) 3. zusätzliche Verlängerung

Art.-Nr.	Länge (L)	Verlängerung	Preis in EURO	Koll.	V.m³	Kg
50SUS02A	37,5	Fenix schwarze Kante		1	0,025	6,5

Fixmaße (II)

Art.-Nr.	Länge (L)	Breite	Beine	Platte	Preis in EURO	Koll.	V.m³	Kg
01NOR03F	139	90	Aluminium lacquered	Fenix schwarze Kante Fenix schwarze Kante		1	0,36	46
01NOR04F	166	90	Aluminium lacquered	Fenix schwarze Kante Fenix schwarze Kante		1	0,42	52
01NOR53F	189	90	Aluminium lacquered	Fenix schwarze Kante Fenix schwarze Kante		1	0,46	57
01NOR30F	209	90	Aluminium lacquered	Fenix schwarze Kante (!) Fenix schwarze Kante (!)		1	0,5	62

Optionals

Art.-Nr.		Preis in EURO	Koll.	V.m³	Kg
02GTA02	 Zuschnitt der Beine nach Maß		-	-	-

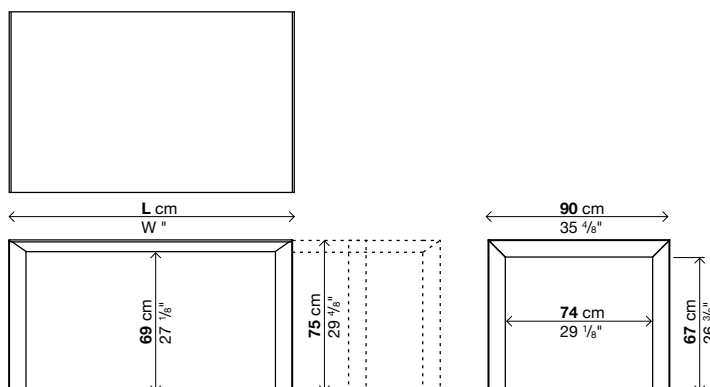

Nori Fenix-NTM®

Erweiterbar/Fixmaße - Breite 100 cm.

Ausführung der Beine:

Eloxiertes Aluminium

Weiß lackiertes Aluminium (farbähnlich wie Ral 9016)

“Fenix-NTM® Grau London” lackiertes Aluminium (farbähnlich wie Ral Design0805005)

“Fenix-NTM® Grau Bromo” lackiertes Aluminium (farbähnlich wie Ral 7012)

Schwarz lackiertes Aluminium (farbähnlich wie Ral 9004)

Olivgrün lackiertes Aluminium (farbähnlich wie “Polyurethan Olivgrün PO08”)

Ausführung der Tischplatte/Verlängerungen:

Fenix-NTM® mit schwarzer Kante (Weiß Kos 0032, Grau London 0718,

Grau Bromo 0724, Schwarz Ingo 0720)

→ Bei den Tischen, deren Artikelnummern mit Sternchen (*) markiert sind, ist das Hinzufügen einer dritten Verlängerung möglich, wodurch der Tisch noch größer wird.

→ Jene Tische, die im ausgezogenen Zustand eine Länge von 250 cm überschreiten, weisen eine leichte Biegung der Platte auf, die jedoch innerhalb der festgelegten qualitativen Standards liegt.

→ Für verstärkte Verpackungen siehe Innenseite des Umschlags.

→ **Schutzhülle “Casper” siehe Seite 74.**

Erweiterbar (▶)

Art.-Nr.	Länge (L)	Breite	Beine	Platte	Preis in EURO	Kolli	V.m ³	Kg
01NOR05*	166-213-260	100	Aluminium	Fenix schwarze Kante		3	0,52	85
			lacquered	Fenix schwarze Kante				
01NOR09*	189-236-283	100	Aluminium	Fenix schwarze Kante		3	0,57	92
			lacquered	Fenix schwarze Kante				
01NOR06*	209-256-303	100	Aluminium	Fenix schwarze Kante		3	0,62	98
			lacquered	Fenix schwarze Kante				

(*) 3. zusätzliche Verlängerung

Art.-Nr.	Länge (L)	Verlängerung	Preis in EURO	Kolli	V.m ³	Kg
50SUS06A	33	Fenix schwarze Kante		1	0,035	6

Fixmaße (II)

Art.-Nr.	Länge (L)	Breite	Beine	Platte	Preis in EURO	Kolli	V.m ³	Kg
01NOR05F	166	100	Aluminium	Fenix schwarze Kante		1	0,45	56
			lacquered	Fenix schwarze Kante				
01NOR07F	189	100	Aluminium	Fenix schwarze Kante		1	0,5	62
			lacquered	Fenix schwarze Kante				
01NOR06F	209	100	Aluminium	Fenix schwarze Kante		1	0,55	67
			lacquered	Fenix schwarze Kante				

Optionals

Art.-Nr.			Preis in EURO	Kolli	V.m ³	Kg
02GTA02		Zuschnitt der Beine nach Maß		-	-	-

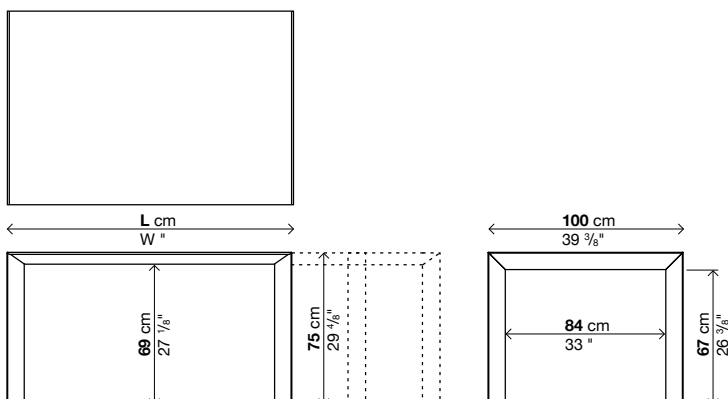

Nori DEKTON® by Cosentino

Erweiterbar/Fixmaße - Breite 90/100 cm.

Ausführung der Beine:

Eloxiertes Aluminium
 Weiß lackiertes Aluminium (farbähnlich wie Ral 9016)
 "Grau Ventus" lackiertes Aluminium
 Olivgrün lackiertes Aluminium (farbähnlich wie "Polyurethan Olivgrün PO08")

Ausführung der Tischplatte:

DEKTON® weiß Zenith
 DEKTON® Grau Ventus
 DEKTON® Aura (digitaler Marmor)

Ausführung der Verlängerungen:

Weiß lackiertes Aluminium (farbähnlich wie Ral 9016)
 "Grau Ventus" lackiertes Aluminium

→ Achtung: Die auf der Oberfläche der Platten aus DEKTON® Aura (digitaler Marmor) nachgebildeten Aderungen werden auf zufällige Art und Weise angebracht, eine Besonderheit, die jede Platte einzigartig und unwiederholbar macht. Dieses Merkmal führt zu eventuellen Unterschieden bei den Mustern, kann jedoch nicht als Imperfektion oder Anomalie beanstandet werden. Aufgrund der gewollten Zufälligkeit ist auch auf Anfrage keine Erzeugung einer mehr oder weniger gleichmäßigen Aderung möglich.

→ Achtung: Die mit (!) gekennzeichneten Maße oder Ausführungen haben eine längere Produktionszeit: zirka 6 Wochen ab Auftragsdatum.

→ Jene Tische, die im ausgezogenen Zustand eine Länge von 250 cm überschreiten, weisen eine leichte Biegung der Platte auf, die jedoch innerhalb der festgelegten qualitativen Standards liegt.

→ Für verstärkte Verpackungen siehe Innenseite des Umschlags.

→ **Schutzhülle "Casper" siehe Seite 74.**

Erweiterbar (▶)

Art.-Nr.	Länge (L)	Breite	Beine	Platte	Preis in EURO	Kolli	V.m ²	Kg
01NOR03	139-176-214	90	Aluminium	DEKTON (!)		3	0,41	89
			lacquered	DEKTON (!)				
01NOR04	166-203-241	90	Aluminium	DEKTON (!)		3	0,5	102
			lacquered	DEKTON (!)				
01NOR08	189-226-263	90	Aluminium	DEKTON (!)		3	0,51	105
			lacquered	DEKTON (!)				
01NOR05	166-203-240	100	Aluminium	DEKTON (!)		3	0,52	108
			lacquered	DEKTON (!)				
01NOR09	189-226-263	100	Aluminium	DEKTON (!)		3	0,57	118
			lacquered	DEKTON (!)				

Fixmaße (II)

Art.-Nr.	Länge (L)	Breite	Beine	Platte	Preis in EURO	Kolli	V.m ²	Kg
01NOR03F	139	90	Aluminium	DEKTON (!)		1	0,36	60
			lacquered	DEKTON (!)				
01NOR04F	166	90	Aluminium	DEKTON (!)		1	0,42	69
			lacquered	DEKTON (!)				
01NOR53F	189	90	Aluminium	DEKTON (!)		1	0,46	76
			lacquered	DEKTON (!)				
01NOR05F	166	100	Aluminium	DEKTON (!)		1	0,45	74
			lacquered	DEKTON (!)				
01NOR07F	189	100	Aluminium	DEKTON (!)		1	0,5	83
			lacquered	DEKTON (!)				
01NOR08F	229	100	Aluminium	DEKTON (!)		1	0,6	97
			lacquered	DEKTON (!)				
01NOR69F	269	100	Aluminium	DEKTON (!)		1	0,69	115
			lacquered	DEKTON (!)				

Optionals

Art.-Nr.		Preis in EURO	Kolli	V.m ²	Kg
02GTA02	 Zuschnitt der Beine nach Maß		-	-	-

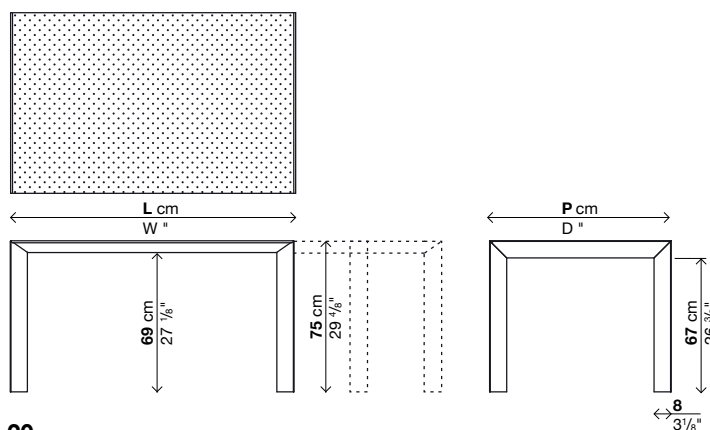

HIGHLY UV RESISTANT



RESISTANT TO ABRASION



RESISTANT TO STAIN



MAXIMUM RESISTANCE TO FIRE AND HEAT



LOW WATER ABSORPTION



HIGH MECHANICAL RESISTANCE



COLOUR STABILITY



DIMENSIONAL STABILITY



FIREPROOF MATERIAL

Nori

Dimensions

Prof. 90 cm
Prof. 35³/₈"

90	139 cm 54 ⁶ / ₈ "	→ Fenix-NTM® → DEKTON®
	139/176/214 cm 54 ⁶ / ₈ /69 ² / ₈ /84 ² / ₈ "	→ Fenix-NTM® → DEKTON®
	166 cm 65 ³ / ₈ "	→ Fenix-NTM® → DEKTON®
	166/203/241/278 cm 65 ³ / ₈ /79 ⁷ / ₈ /94 ⁷ / ₈ /109 ⁴ / ₈ "	→ Fenix-NTM®
	166/203/241 cm 65 ³ / ₈ /79 ⁷ / ₈ /94 ⁷ / ₈ "	→ DEKTON®
	189 cm 74 ³ / ₈ "	→ Fenix-NTM® → DEKTON®
	189/226/263 cm 74 ³ / ₈ /89/103 ⁴ / ₈ " *	→ Fenix-NTM®
	189/226/263 cm 74 ³ / ₈ /89/103 ⁴ / ₈ "	→ DEKTON®
	209 cm 82 ² / ₈ "	→ Fenix-NTM®
209/246/283 cm 82 ² / ₈ /96 ⁷ / ₈ /111 ³ / ₈ " *	→ Fenix-NTM®	

Prof. 90 cm
Prof. 35³/₈"

90	159 cm 62 ⁵ / ₈ "	→ Teck
	159/199/239 cm 62 ⁵ / ₈ /78 ³ / ₈ /94 ¹ / ₈ "	→ Teck
	179 cm 70 ⁴ / ₈ "	→ Teck
	179/219/259 cm 70 ⁴ / ₈ /86 ² / ₈ /102"	→ Teck
	199 cm 78 ³ / ₈ "	→ Teck
	199/239/279 cm 78 ³ / ₈ /94 ¹ / ₈ /109 ⁷ / ₈ "	→ Teck
	219 cm 86 ² / ₈ "	→ Teck
	219/259/299 cm 86 ² / ₈ /102/117 ⁶ / ₈ "	→ Teck
	259 cm 102"	→ Teck
298 cm 117 ⁶ / ₈ "	→ Teck	

Prof. 100 cm
Prof. 39³/₈"

100	166 cm 65 ³ / ₈ "	→ Fenix-NTM® → DEKTON®
	166/213/260 cm 65 ³ / ₈ /83 ⁷ / ₈ /102 ³ / ₈ " *	→ Fenix-NTM®
	166/203/240 cm 65 ³ / ₈ /79 ⁷ / ₈ /94 ⁴ / ₈ "	→ DEKTON®
	189 cm 74 ³ / ₈ "	→ Fenix-NTM® → DEKTON®
	189/236/283 cm 74 ³ / ₈ /92 ⁷ / ₈ /111 ³ / ₈ " *	→ Fenix-NTM®
	189/226/263 cm 74 ³ / ₈ /89/103 ⁴ / ₈ "	→ DEKTON®
	209 cm 82 ² / ₈ "	→ Fenix-NTM®
	209/256/303 cm 82 ² / ₈ /100 ⁶ / ₈ /119 ² / ₈ " *	→ Fenix-NTM®
	229 cm 90 ¹ / ₈ "	→ DEKTON®
269 cm 105 ⁷ / ₈ "	→ DEKTON®	

* = 3ème rallonge supplémentaire (sur demande)

Plateaux

Prof. 100 cm Prof. 393/8"

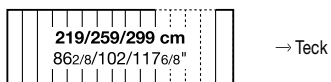
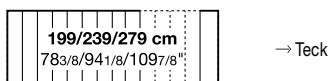
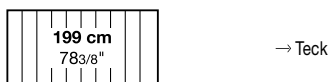
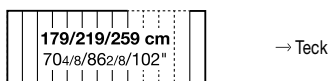

Prof. 124 cm Prof. 487/8"

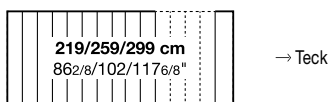

Fenix-NTM® chant noir Ép. 10 mm

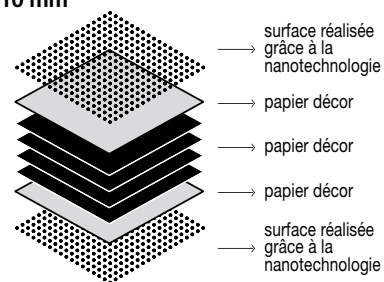
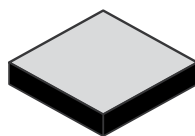

DEKTON® by Cosentino Ép. 8 mm

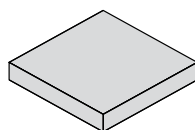

Dekton est un mélange sophistiqué de matières premières utilisées pour la fabrication du verre, de céramique de dernière génération et de surfaces en quartz de très haute qualité

Teck Ép. 20 mm

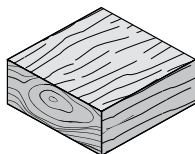

Au fil des années, le teck non traité obtiendra sa typique couleur argentée qui caractérise cette essence lorsqu'on la laisse à l'extérieur. Cette transformation esthétique ne modifie aucunement la qualité ou la résistance de ce matériau.

Pour le nettoyage courant du teck, on pourra utiliser un nettoyeur pour meubles d'extérieur en bois ou bien tout simplement une brosse à poils souples et de l'eau.

Pour éviter que la surface du produit neuf s'oxyde, il est possible d'appliquer **ICADECK** (huile à base d'eau).

Pour éliminer la patine grise dérivant de l'oxydation de la surface et rétablir la couleur d'origine du teck, utiliser **CLEANDECK** (nettoyant anti-gris). Le traitement avec le produit **CLEANDECK** doit être suivi d'un lavage puis de l'application du produit **ICADECK** une fois que la surface sera bien sèche.

Ne pas utiliser de nettoyeur à haute pression qui pourrait endommager la surface et les fibres du bois. Pour éliminer les rayures en surface, on pourra utiliser du papier de verre ou bien une cale à poncer.

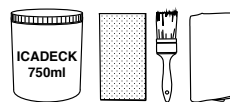

KIT ICADECK

ICADECK + éponge abrasive + pinceau + chiffon



ICADECK



CLEANDECK

Code	Prix en EURO	Cols	m ²	Kg
02KITOUT01 KIT ICADECK (huile à base d'eau)		1	0,01	2
02KITOUT02 ICADECK (huile à base d'eau)		1	0,01	1,5
02KITOUT03 CLEANDECK (nettoyant anti-gris)		1	0,01	1,5

Nori Fenix-NTM®

Extensible/Fixe - Prof. 90 cm.

Finition piètement:

Aluminium anodisé

Aluminium laqué blanc (semblable au Ral 9016)

Aluminium laqué "Fenix-NTM® gris Londres" (semblable au Ral Design0805005)

Aluminium laqué "Fenix-NTM® gris Bromo" (semblable au Ral 7012)

Aluminium laqué noir (semblable au Ral 9004)

Aluminium laqué vert olive (coloris de référence "Polyuréthane vert olive PO08")

Finition du plateau/rallonges:

Fenix-NTM® chant noir (blanc Kos 0032, gris Londres 0718, gris Bromo 0724, noir Ingo 0720)

→ Pour les modèles de table marqués d'un astérisque (*), il est possible d'ajouter une troisième rallonge pour augmenter davantage l'extension.

→ Attention: les dimensions ou les finitions suivies du symbole (!) ont des délais de fabrication plus longs, à savoir environ 6 semaines à partir de la date de la commande.

→ Les tables qui une fois allongées font plus de 250 cm présentent une légère flexion du plateau qui respecte les standards de qualité acceptés.

→ Pour emballages renforcés, voir intérieur de la couverture.

→ **Housse de protection "Casper", voir page 74.**

Extensible (▶)

Code	Longueur (L)	Prof.	Pieds	Plateau	Prix en EURO	Coils	m ²	Kg
01NOR03	139-176-214	90	aluminium	Fenix chant noir		3	0,41	71
			lacquered	Fenix chant noir				
01NOR04	166-203-241-278 <small>3ème extension compris standard</small>	90	aluminium	Fenix chant noir		4	0,5	81
			lacquered	Fenix chant noir				
01NOR08*	189-226-263	90	aluminium	Fenix chant noir		3	0,51	82
			lacquered	Fenix chant noir				
01NOR30*	209-246-283	90	aluminium	Fenix chant noir (!)		3	0,55	88
			lacquered	Fenix chant noir (!)				

(*) 3ème rallonge supplémentaire

Code	Longueur (L)	Rallonge	Prix en EURO	Coils	m ²	Kg
50SUS02A	37,5	Fenix chant noir		1	0,025	6,5

Fixe (II)

Code	Longueur (L)	Prof.	Pieds	Plateau	Prix en EURO	Coils	m ²	Kg
01NOR03F	139	90	aluminium	Fenix chant noir		1	0,36	46
			lacquered	Fenix chant noir				
01NOR04F	166	90	aluminium	Fenix chant noir		1	0,42	52
			lacquered	Fenix chant noir				
01NOR53F	189	90	aluminium	Fenix chant noir		1	0,46	57
			lacquered	Fenix chant noir				
01NOR30F	209	90	aluminium	Fenix chant noir (!)		1	0,5	62
			lacquered	Fenix chant noir (!)				

Optionals

Code		Prix en EURO	Coils	m ²	Kg
02GTA02	 coupe des pieds sur mesure		-	-	-

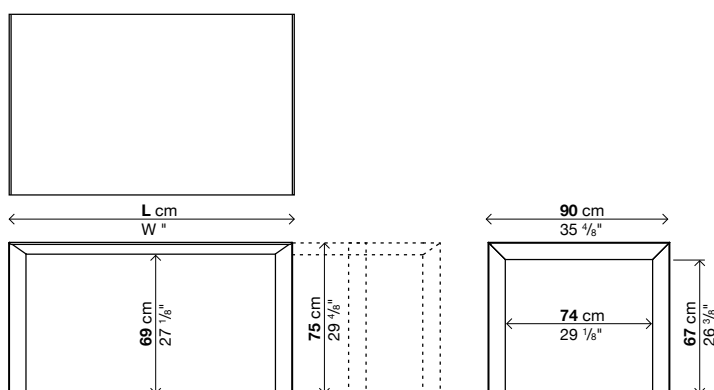

Nori Fenix-NTM®

Extensible/Fixed - Depth 100 cm.

Finition piètement:

Aluminium anodisé

Aluminium laqué blanc (semblable au Ral 9016)

Aluminium laqué "Fenix-NTM® gris Londres" (semblable au Ral Design0805005)

Aluminium laqué "Fenix-NTM® gris Bromo" (semblable au Ral 7012)

Aluminium laqué noir (semblable au Ral 9004)

Aluminium laqué vert olive (coloris de référence "Polyuréthane vert olive PO08")

Finition du plateau/rallonges:

Fenix-NTM® chant noir (blanc Kos 0032, gris Londres 0718, gris Bromo 0724, noir Ingo 0720)

→ Pour les modèles de table marqués d'un astérisque (*), il est possible d'ajouter une troisième rallonge pour augmenter davantage l'extension.

→ Les tables qui une fois allongées font plus de 250 cm présentent une légère flexion du plateau qui respecte les standards de qualité acceptés.

→ Pour emballages renforcés, voir intérieur de la couverture.

→ **Housse de protection "Casper", voir page 74.**

Extensible (►)

Code	Longueur (L)	Prof.	Pieds	Plateau	Prix en EURO	Coils	m ²	Kg
01NOR05*	166-213-260	100	aluminium	Fenix chant noir		3	0,52	85
			lacquered	Fenix chant noir				
01NOR09*	189-236-283	100	aluminium	Fenix chant noir		3	0,57	92
			lacquered	Fenix chant noir				
01NOR06*	209-256-303	100	aluminium	Fenix chant noir		3	0,62	98
			lacquered	Fenix chant noir				

(*) 3ème rallonge supplémentaire

Code	Longueur (L)	Rallonge	Prix en EURO	Coils	m ²	Kg
50SUS06A	33	Fenix chant noir		1	0,035	6

Fixe (II)

Code	Longueur (L)	Prof.	Pieds	Plateau	Prix en EURO	Coils	m ²	Kg
01NOR05F	166	100	aluminium	Fenix chant noir		1	0,45	56
			lacquered	Fenix chant noir				
01NOR07F	189	100	aluminium	Fenix chant noir		1	0,5	62
			lacquered	Fenix chant noir				
01NOR06F	209	100	aluminium	Fenix chant noir		1	0,55	67
			lacquered	Fenix chant noir				

Optionals

Code		Prix en EURO	Coils	m ²	Kg
02GTA02	 coupe des pieds sur mesure		-	-	-

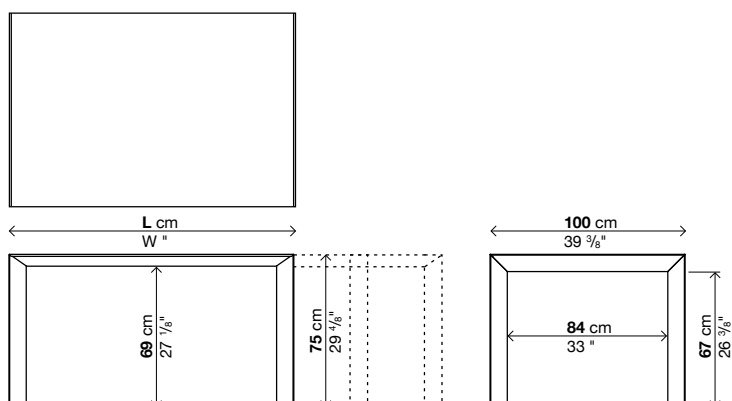

Nori DEKTON® by Cosentino

Extensible/Fixe - Prof. 90/100 cm.

Finition piètement:

Aluminium anodisé
 Aluminium laqué blanc (semblable au Ral 9016)
 Aluminium laqué "gris Ventus"
 Aluminium laqué vert olive (coloris de référence "Polyuréthane vert olive PO08")

Finition du plateau:

DEKTON® blanc Zenith
 DEKTON® gris Ventus
 DEKTON® Aura (effet marbre numérique)

Finition des rallonges:

Aluminium laqué blanc (semblable au Ral 9016)
 Aluminium laqué "gris Ventus"

→ Attention: les veines imprimées sur la surface des plateaux en DEKTON® Aura (effet marbre) sont disposées de façon aléatoire, ce qui rend chaque plateau unique puisque une reproduction exacte est bien entendu impossible. Cette caractéristique implique qu'il pourrait y avoir des différences par rapport aux échantillons, mais celles-ci ne pourront en aucun cas faire l'objet de contestations au titre d'imperfections ou d'anomalies. Du fait que l'impression réalisée est du type aléatoire, aucune demande concernant l'homogénéité des veines ne pourra être acceptée.

→ Attention: les dimensions et les finitions marquées par un point d'exclamation (!) ont des délais de production plus longs (environ 6 semaines à partir de la date de la commande).

→ Les tables qui une fois allongées font plus de 250 cm présentent une légère flexion du plateau qui respecte les standards de qualité acceptés.

→ Pour emballages renforcés, voir intérieur de la couverture.

→ Housse de protection "Casper", voir page 74.

Extensible (►)

Code	Longueur (L)	Prof.	Pieds	Plateau	Prix en EURO	Coll.	m ²	Kg
01NOR03	139-176-214	90	aluminium	DEKTON (!)		3	0,41	89
			lacquered	DEKTON (!)				
01NOR04	166-203-241	90	aluminium	DEKTON (!)		3	0,5	102
			lacquered	DEKTON (!)				
01NOR08	189-226-263	90	aluminium	DEKTON (!)		3	0,51	105
			lacquered	DEKTON (!)				
01NOR05	166-203-240	100	aluminium	DEKTON (!)		3	0,52	108
			lacquered	DEKTON (!)				
01NOR09	189-226-263	100	aluminium	DEKTON (!)		3	0,57	118
			lacquered	DEKTON (!)				

Fixe (II)

Code	Longueur (L)	Prof.	Pieds	Plateau	Prix en EURO	Coll.	m ²	Kg
01NOR03F	139	90	aluminium	DEKTON (!)		1	0,36	60
			lacquered	DEKTON (!)				
01NOR04F	166	90	aluminium	DEKTON (!)		1	0,42	69
			lacquered	DEKTON (!)				
01NOR53F	189	90	aluminium	DEKTON (!)		1	0,46	76
			lacquered	DEKTON (!)				
01NOR05F	166	100	aluminium	DEKTON (!)		1	0,45	74
			lacquered	DEKTON (!)				
01NOR07F	189	100	aluminium	DEKTON (!)		1	0,5	83
			lacquered	DEKTON (!)				
01NOR08F	229	100	aluminium	DEKTON (!)		1	0,6	97
			lacquered	DEKTON (!)				
01NOR69F	269	100	aluminium	DEKTON (!)		1	0,69	115
			lacquered	DEKTON (!)				

Optionals

Code		Prix en EURO	coll.	m ²	Kg
02GTA02	 coupe des pieds sur mesure	-	-	-	-

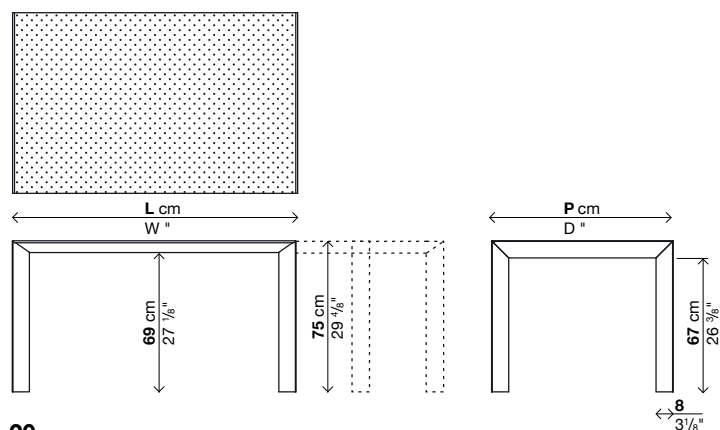

Nori

Dimensiones

Prof. 90 cm
Prof. 35³/₈"

90	139 cm 54 ⁶ / ₈ "	→ Fenix-NTM® → DEKTON®
	139/176/214 cm 54 ⁶ / ₈ /69 ² / ₈ /84 ² / ₈ "	→ Fenix-NTM® → DEKTON®
	166 cm 65 ³ / ₈ "	→ Fenix-NTM® → DEKTON®
	166/203/241/278 cm 65 ³ / ₈ /79 ⁷ / ₈ /94 ⁷ / ₈ /109 ⁴ / ₈ "	→ Fenix-NTM®
	166/203/241 cm 65 ³ / ₈ /79 ⁷ / ₈ /94 ⁷ / ₈ "	→ DEKTON®
	189 cm 74 ³ / ₈ "	→ Fenix-NTM® → DEKTON®
	189/226/263 cm 74 ³ / ₈ /89/103 ⁴ / ₈ " *	→ Fenix-NTM®
	189/226/263 cm 74 ³ / ₈ /89/103 ⁴ / ₈ "	→ DEKTON®
	209 cm 82 ² / ₈ "	→ Fenix-NTM®
209/246/283 cm 82 ² / ₈ /96 ⁷ / ₈ /111 ³ / ₈ " *	→ Fenix-NTM®	

Prof. 90 cm
Prof. 35³/₈"

90	159 cm 62 ⁵ / ₈ "	→ Teca
	159/199/239 cm 62 ⁵ / ₈ /78 ³ / ₈ /94 ¹ / ₈ "	→ Teca
	179 cm 70 ⁴ / ₈ "	→ Teca
	179/219/259 cm 70 ⁴ / ₈ /86 ² / ₈ /102"	→ Teca
	199 cm 78 ³ / ₈ "	→ Teca
	199/239/279 cm 78 ³ / ₈ /94 ¹ / ₈ /109 ⁷ / ₈ "	→ Teca
	219 cm 86 ² / ₈ "	→ Teca
	219/259/299 cm 86 ² / ₈ /102/117 ⁶ / ₈ "	→ Teca
	259 cm 102"	→ Teca
298 cm 117 ⁶ / ₈ "	→ Teca	

Prof. 100 cm
Prof. 39³/₈"

100	166 cm 65 ³ / ₈ "	→ Fenix-NTM® → DEKTON®
	166/213/260 cm 65 ³ / ₈ /83 ⁷ / ₈ /102 ³ / ₈ " *	→ Fenix-NTM®
	166/203/240 cm 65 ³ / ₈ /79 ⁷ / ₈ /94 ⁴ / ₈ "	→ DEKTON®
	189 cm 74 ³ / ₈ "	→ Fenix-NTM® → DEKTON®
	189/236/283 cm 74 ³ / ₈ /92 ⁷ / ₈ /111 ³ / ₈ " *	→ Fenix-NTM®
	189/226/263 cm 74 ³ / ₈ /89/103 ⁴ / ₈ "	→ DEKTON®
	209 cm 82 ² / ₈ "	→ Fenix-NTM®
	209/256/303 cm 82 ² / ₈ /100 ⁶ / ₈ /119 ² / ₈ " *	→ Fenix-NTM®
	229 cm 90 ¹ / ₈ "	→ DEKTON®
269 cm 105 ⁷ / ₈ "	→ DEKTON®	

* = 3ª prolongación adicional (bajo petición)

Sobres

Prof. 100 cm Prof. 39³/₈"

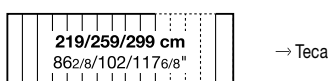
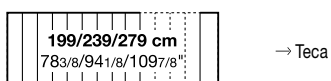
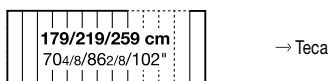
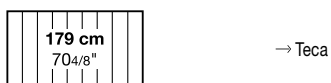

Prof. 124 cm Prof. 48⁷/₈"

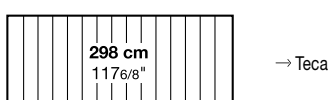
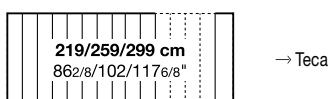

Fenix-NTM® borde negro Esp. 10 mm

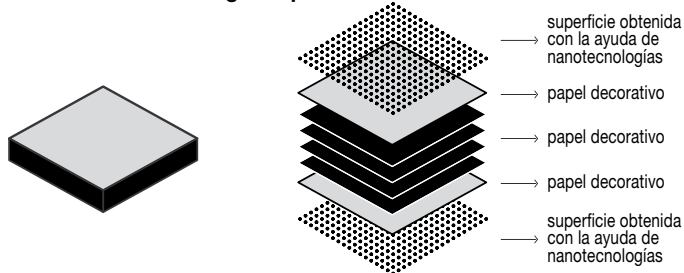

DEKTON® by Cosentino Esp. 8 mm



Teca Esp. 20 mm

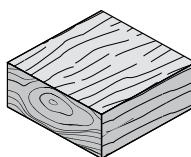

Con el paso del tiempo, la teca no tratada adoptará el típico color plateado que caracteriza a esta madera cuando se utiliza al aire libre. Este proceso estético no influye en la calidad o la resistencia del material.

Para la limpieza normal de la teca se puede utilizar un detergente específico para muebles de madera de exteriores o simplemente un cepillo de cerda blanda con agua.

Para evitar la oxidación superficial del producto nuevo, se puede aplicar **ICADECK** (aceite al agua)

Para eliminar la pátina gris debida a la oxidación y restablecer el color original de la teca, utilizar **CLEANECK** (detergente antigris). El tratamiento con **CLEANECK** debe ir seguido de un lavado y de la aplicación de **ICADECK** sobre la superficie seca.

Se desaconseja el uso de hidrolimpiadoras, dado que podrían dañar la superficie y las fibras de la madera. Para eliminar las rayas superficiales se puede utilizar papel de lija o una lijadora manual.

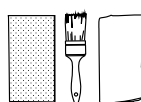

KIT ICADECK
ICADECK + esponja abrasiva + pincel + paño

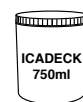

ICADECK



CLEANECK

Código	Precios EURO	Packs Vol. m ³ Kg
02KITOUT01 KIT ICADECK (aceite al agua)		1 0,01 2
02KITOUT02 ICADECK (aceite al agua)		1 0,01 1,5
02KITOUT03 CLEANECK (detergente antigris)		1 0,01 1,5

Nori Fenix-NTM®

Extensible/Fija - Prof. 90 cm.

Acabado patas:

Aluminio anodizado

Aluminio barnizado blanco (parecido al Ral 9016)

Aluminio barnizado "Fenix-NTM® gris Londres" (parecido al Ral Design0805005)

Aluminio barnizado "Fenix-NTM® gris Bromo" (parecido al Ral 7012)

Aluminio barnizado negro (parecido al Ral 9004)

Aluminio barnizado verde oliva (ref. color "Poliuretano verde oliva PO08")

Acabado sobre/prolongaciones:

Fenix-NTM® borde negro (blanco Kos 0032, gris Londres 0718,

gris Bromo 0724, negro Ingo 0720)

→ En las mesas con códigos marcados con un asterisco (*) existe la posibilidad de añadir la tercera prolongación para alargarlas todavía más.

→ Atención: las medidas o los acabados marcados con (!) tienen tiempos de producción más largos, de unas 6 semanas a partir de la fecha del pedido.

→ Las mesas que superan los 250 cm extendidas presentan una ligera flexión del sobre que respeta los estándares de calidad aceptados.

→ Embalajes reforzados, ver lado interno de la portada.

→ **Funda de protección "Casper" ver pág. 74.**

Extensible (►)

Código	Longitud (L)	Prof.	Patas	Sobre	Precios EURO	Packs	Vol.m³	Kg
01NOR03	139-176-214	90	aluminio	Fenix borde negro		3	0,41	71
			lacquered	Fenix borde negro				
01NOR04	166-203-241-278 <small>Tercera prolongación de serie</small>	90	aluminio	Fenix borde negro		4	0,5	81
			lacquered	Fenix borde negro				
01NOR08*	189-226-263	90	aluminio	Fenix borde negro		3	0,51	82
			lacquered	Fenix borde negro				
01NOR30*	209-246-283	90	aluminio	Fenix borde negro (!)		3	0,55	88
			lacquered	Fenix borde negro (!)				

(*) 3ª prolongación adicional

Código	Longitud (L)	Prolongación	Precios EURO	Packs	Vol.m³	Kg
50SUS02A	37,5	Fenix borde negro		1	0,025	6,5

Fija (II)

Código	Longitud (L)	Prof.	Patas	Sobre	Precios EURO	Packs	Vol.m³	Kg
01NOR03F	139	90	aluminio	Fenix borde negro		1	0,36	46
			lacquered	Fenix borde negro				
01NOR04F	166	90	aluminio	Fenix borde negro		1	0,42	52
			lacquered	Fenix borde negro				
01NOR53F	189	90	aluminio	Fenix borde negro		1	0,46	57
			lacquered	Fenix borde negro				
01NOR30F	209	90	aluminio	Fenix borde negro (!)		1	0,5	62
			lacquered	Fenix borde negro (!)				

Opcionales

Código			Precios EURO	Packs	Vol.m³	Kg
02GTA02		cutte pata a medida		-	-	-

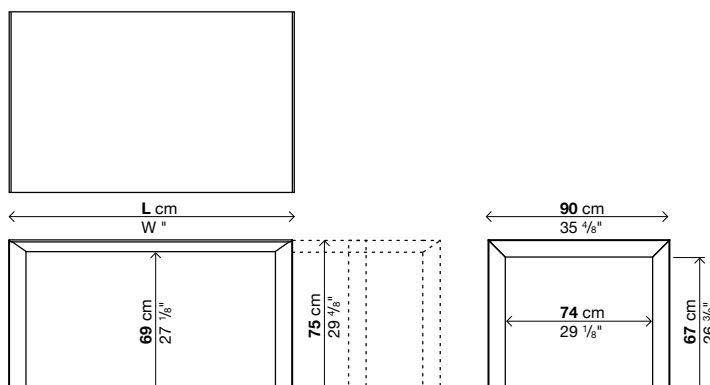

Nori Fenix-NTM®

Extensible/Fija - Prof. 100 cm.

Acabado patas:

Aluminio anodizado

Aluminio barnizado blanco (parecido al Ral 9016)

Aluminio barnizado "Fenix-NTM® gris Londres" (parecido al Ral Design0805005)

Aluminio barnizado "Fenix-NTM® gris Bromo" (parecido al Ral 7012)

Aluminio barnizado negro (parecido al Ral 9004)

Aluminio barnizado verde oliva (ref. color "Poliuretano verde oliva PO08")

Acabado sobre/prolongaciones:

Fenix-NTM® borde negro (blanco Kos 0032, gris Londres 0718,

gris Bromo 0724, negro Ingo 0720)

→ En las mesas con códigos marcados con un asterisco (*) existe la posibilidad de añadir la tercera prolongación para alargarlas todavía más.

→ Las mesas que superan los 250 cm extendidas presentan una ligera flexión del sobre que respeta los estándares de calidad aceptados.

→ Embalajes reforzados, ver lado interno de la portada.

→ **Funda de protección "Casper" ver pág. 74.**

Extensible (►)

Código	Longitud (L)	Prof.	Patatas	Sobre	Precios EURO	Packs	Vol. m ³	Kg
01NOR05*	166-213-260	100	aluminio	Fenix borde negro		3	0,52	85
			lacquered	Fenix borde negro				
01NOR09*	189-236-283	100	aluminio	Fenix borde negro		3	0,57	92
			lacquered	Fenix borde negro				
01NOR06*	209-256-303	100	aluminio	Fenix borde negro		3	0,62	98
			lacquered	Fenix borde negro				

(*) 3ª prolongación adicional

Código	Longitud (L)	Prolongación	Precios EURO	Packs	Vol. m ³	Kg
50SUS06A	33	Fenix borde negro		1	0,035	6

Fija (II)

Código	Longitud (L)	Prof.	Patatas	Sobre	Precios EURO	Packs	Vol. m ³	Kg
01NOR05F	166	100	aluminio	Fenix borde negro		1	0,45	56
			lacquered	Fenix borde negro				
01NOR07F	189	100	aluminio	Fenix borde negro		1	0,5	62
			lacquered	Fenix borde negro				
01NOR06F	209	100	aluminio	Fenix borde negro		1	0,55	67
			lacquered	Fenix borde negro				

Opcionales

Código			Precios EURO	Packs	Vol. m ³	Kg
02GTA02		corte pata a medida		-	-	-

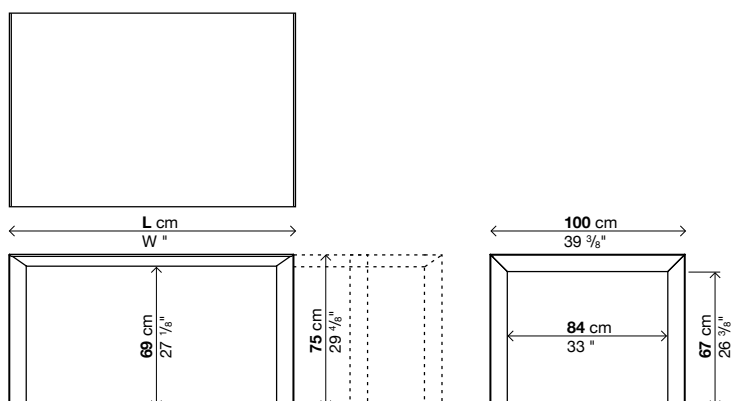

Nori DEKTON® by Cosentino

Extensible/Fija - Prof. 90/100 cm.

Acabado patas:

Aluminio anodizado
Aluminio barnizado blanco (parecido al Ral 9016)
Aluminio barnizado "gris Ventus"
Aluminio barnizado verde oliva (ref. color "Poliuretano verde oliva PO08")

Acabado sobre:

DEKTON® blanco Zenith
DEKTON® gris Ventus
DEKTON® Aura (mármol digital)

Acabado prolongaciones:

Aluminio barnizado blanco (parecido al Ral 9016)
Aluminio barnizado "gris Ventus"

→ Atención: los veteados reproducidos sobre la superficie de los sobres de DEKTON® Aura (mármol digital) están dispuestos de modo casual, peculiaridad que hace que cada sobre resulte único e irrepetible. Esta característica implica posibles diferencias respecto a las muestras, que no pueden considerarse como imperfecciones o anomalías objeto de reclamación. Debido a la casualidad de su disposición, no es posible obtener bajo pedido veteados más o menos homogéneos.

→ Atención: las medidas o los acabados marcados con (!) tienen los tiempos de producción más largos, de aproximadamente 6 semanas desde la fecha del pedido.

→ Las mesas que superan los 250 cm extendidas presentan una ligera flexión del sobre que respeta los estándares de calidad aceptados.

→ Embalajes reforzados, ver lado interno de la portada.

→ Funda de protección "Casper" ver pág. 74.

Extensible (▶)

Código	Longitud (L)	Prof.	Patatas	Sobre	Precios EURO	Packs	Vol. m ³	Kg
01NOR03	139-176-214	90	aluminio	DEKTON (!)		3	0,41	89
			lacquered	DEKTON (!)				
01NOR04	166-203-241	90	aluminio	DEKTON (!)		3	0,5	102
			lacquered	DEKTON (!)				
01NOR08	189-226-263	90	aluminio	DEKTON (!)		3	0,51	105
			lacquered	DEKTON (!)				
01NOR05	166-203-240	100	aluminio	DEKTON (!)		3	0,52	108
			lacquered	DEKTON (!)				
01NOR09	189-226-263	100	aluminio	DEKTON (!)		3	0,57	118
			lacquered	DEKTON (!)				

Fija (II)

Código	Longitud (L)	Prof.	Patatas	Sobre	Precios EURO	Packs	Vol. m ³	Kg
01NOR03F	139	90	aluminio	DEKTON (!)		1	0,36	60
			lacquered	DEKTON (!)				
01NOR04F	166	90	aluminio	DEKTON (!)		1	0,42	69
			lacquered	DEKTON (!)				
01NOR53F	189	90	aluminio	DEKTON (!)		1	0,46	76
			lacquered	DEKTON (!)				
01NOR05F	166	100	aluminio	DEKTON (!)		1	0,45	74
			lacquered	DEKTON (!)				
01NOR07F	189	100	aluminio	DEKTON (!)		1	0,5	83
			lacquered	DEKTON (!)				
01NOR08F	229	100	aluminio	DEKTON (!)		1	0,6	97
			lacquered	DEKTON (!)				
01NOR69F	269	100	aluminio	DEKTON (!)		1	0,69	115
			lacquered	DEKTON (!)				

Opcionales

Código		Precios EURO	coll.	m ²	Kg
02GTA02	 corte pata a medida	-	-	-	-

