

DAVIS OUT

Design Gianfranco Frigerio

VERSIONE DAVIS OUT: bracciolo con struttura in legno multistrato imbottito in poliuretano espanso indeformabile rivestito con trapuntino in piuma d'oca (Assopiuma). Larghezza bracciolo cm 18.

Struttura: legno multistrato imbottito in poliuretano espanso indeformabile rivestito in tessuto protettivo accoppiato. Il modello è dotato di piedini centrali di sicurezza.

Cuscini seduta: disponibili 3 varianti: GOOSE in piuma d'oca (Assopiuma) con inserto in poliuretano; POLMD in poliuretano espanso indeformabile media densità e fibra sintetica ricoperti con fodera in cotone; POLHD in poliuretano espanso indeformabile alta densità e fibra sintetica ricoperti con fodera in cotone.

Cuscini schienale: rialzabili (brevetto Frigerio), in piuma d'oca (Assopiuma) con inserto in poliuretano indeformabile.

Piedini: disponibili in 5 differenti varianti: P, M, L, R e T

Cuscinetto: piuma d'oca (Assopiuma).

Rivestimento: sfoderabile in tessuto, fisso in pelle.

Profilo: esclusivamente sul cuscino seduta, nello stesso materiale e colore del rivestimento. Su richiesta in contrasto esclusivamente in Grosgrain.

ACCESSORI

| **cuscini decorativi:** include cuscini decorativi in dimensioni specifiche in piuma d'oca.

| **elemento Fly:** tavolino retrodivano con struttura in metallo color Brunito. Top in legno.

| **Cabinet:** elemento Cabinet in legno, con o senza luce, nelle finiture della collezione Frigerio.

| **Back:** elemento schienale rialzabile per soluzioni angolari.

| **Pouf:** completa la collezione una serie di pouf coordinati in differenti misure.

VERSION DAVIS OUT: armrest with structure in plywood padded with non-deformable polyurethane foam covered with quilt in goose down (Assopiuma). Armrest width 18cm.

Structure: plywood padded with non-deformable polyurethane foam covered with doubled protective fabric. The model is provided with central security feet.

Seat cushions: available in 3 different variants: GOOSE in goose down (Assopiuma) with core in non-deformable polyurethane foam; POLMD in medium density non-deformable polyurethane foam and synthetic fibre layer covered with cotton fabric; POLHD in hard density non-deformable polyurethane foam and synthetic fibre layer covered with cotton fabric.

Back cushions: with adjustable movement in height (Frigerio patent), in goose down (Assopiuma) with core in non-deformable polyurethane foam.

Feet: available in 5 different variants: P, M, L, R e T

Small cushions: goose down (Assopiuma).

Cover: removable in fabric, fix in leather.

Piping: on seat cushion only, in the same material and colour as the cover. On request in contrast exclusively in Grosgrain.

ACCESSORIES

| **beauty cushions:** including beauty cushions in specific sizes in goose down.

| **Fly element:** low tables for placement as sofa-back in metal Burnished colour. Top in wood.

| **Cabinet:** Cabinet element in wood, with or without light, in finishes of the Frigerio collection.

| **Back:** adjustable raising back element for corner solution.

| **Pouf:** the collection is completed with a range of coordinated poufs in different sizes.



DAVIS SYSTEM
Design Gianfranco Frigerio

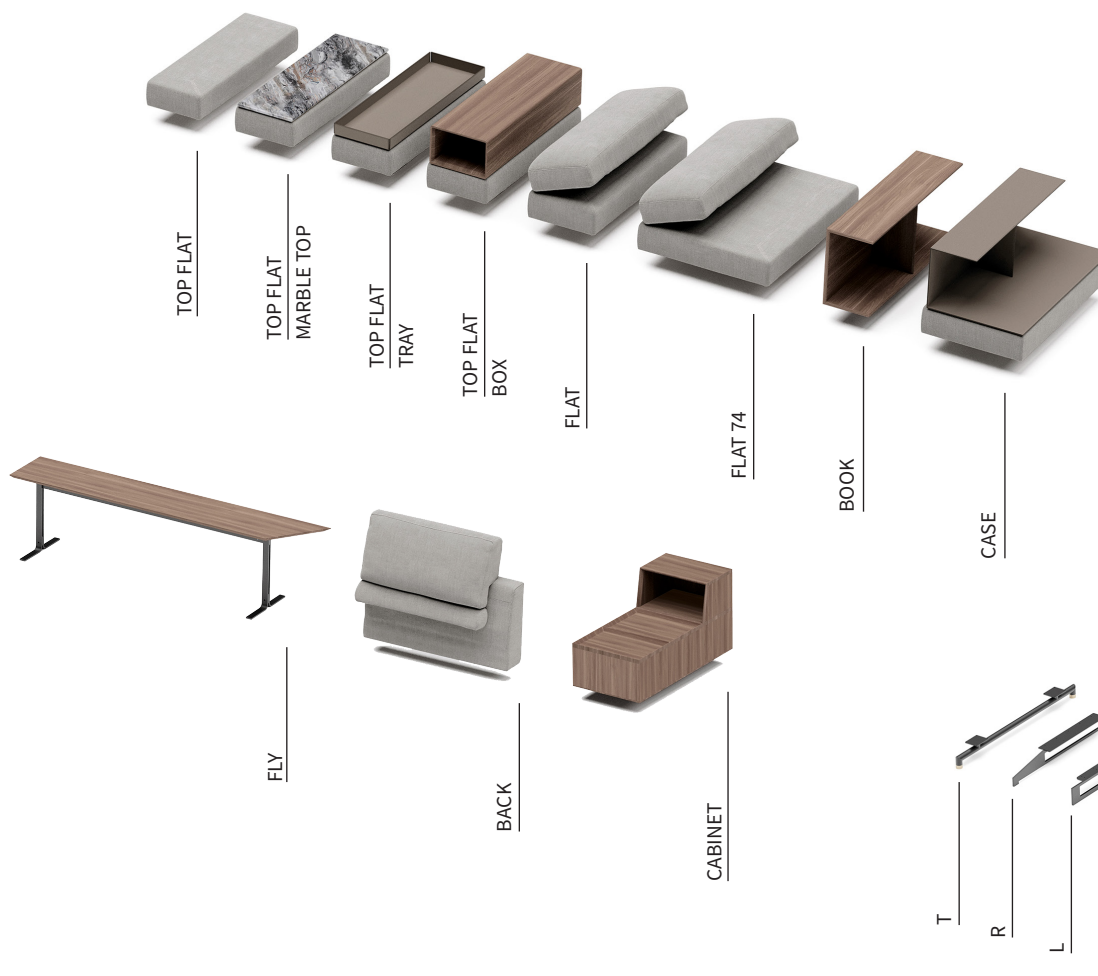

Dimensioni espresse in cm se non diversamente indicato.
L'Azienda si riserva il diritto di apportare modifiche ai modelli senza preavviso.
Tolleranza sulle misure indicate di +/- 2%.

Dimensions in centimeter if not differently indicated.
The Company reserves the right to change the models without any advance notice.
Tolerance on the given sizes +/- 2%.

BRACCIOLI / ARMRESTS

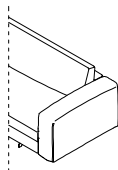

cod. 12133

Bracciolo **TWIN 23 cm** / Armrest **TWIN 23 cm**

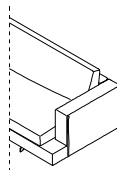
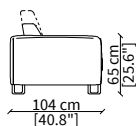
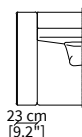
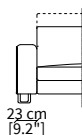

cod. 12545

Bracciolo **STYLE 18 cm** / Armrest **STYLE 18 cm**

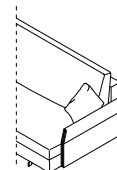
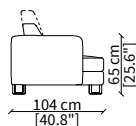
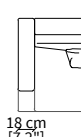
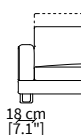

cod. 12547

Bracciolo **SLIM 8 cm** / Armrest **SLIM 8 cm**

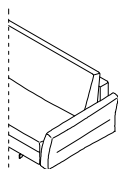
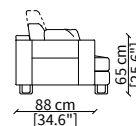
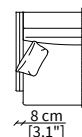

cod. 12546

Bracciolo **WAVE 26 cm** / Armrest **WAVE 26 cm**

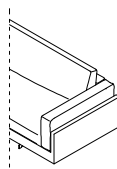
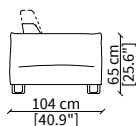
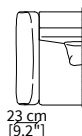

cod. 12100

Bracciolo **IN 22 cm** / Armrest **IN 22 cm**

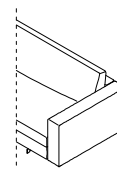
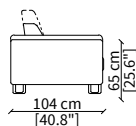
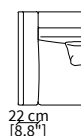
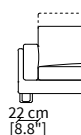

cod. 12101

Bracciolo **OUT 18 cm** / Armrest **OUT 18 cm**

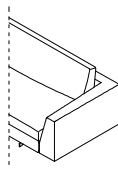
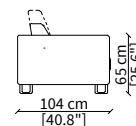
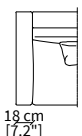
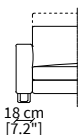

cod. 12124

Bracciolo **FREE 12/25 cm** / Armrest **FREE 12/25 cm**

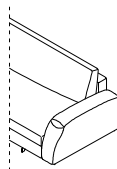
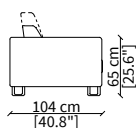
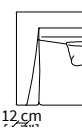
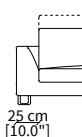

cod. 12139

Bracciolo **CLASS 19 cm** / Armrest **CLASS 19 cm**

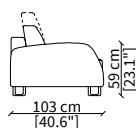
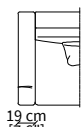
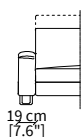

Dimensioni espresse in cm se non diversamente indicato.
L'Azienda si riserva il diritto di apportare modifiche ai modelli senza preavviso.
Tolleranza sulle misure indicate di +/- 2%.

Dimensions in centimeter if not differently indicated.
The Company reserves the right to change the models without any advance notice.
Tolerance on the given sizes +/- 2%.

BRACCIOLI / ARMRESTS

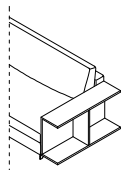

cod. 12138

Bracciolo **BOOK 27 cm** / Armrest **BOOK 27 cm**

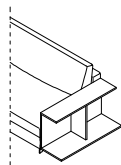
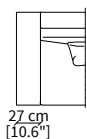
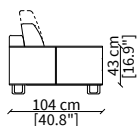
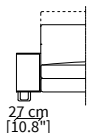

cod. 12158

Bracciolo **BOOK 36 cm** / Armrest **BOOK 36 cm**

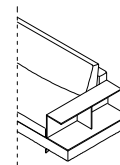
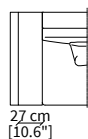
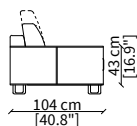
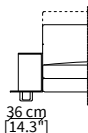

cod. 12148

Bracciolo **CASE 36 cm** / Armrest **CASE 36 cm**

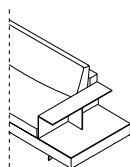
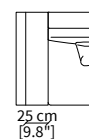
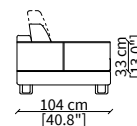
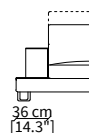

cod. 12526

Bracciolo **CASE 56 cm** / Armrest **CASE 56 cm**

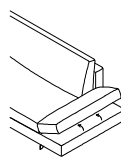
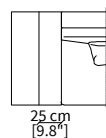
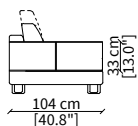
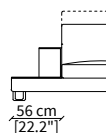

cod. 12126

Bracciolo **FLAT 36 cm** / Armrest **FLAT 36 cm**

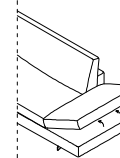
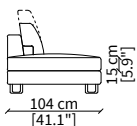
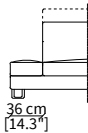

cod. 12125

Bracciolo **FLAT 56 cm** / Armrest **FLAT 56 cm**

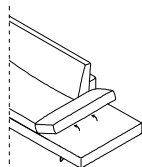
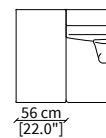
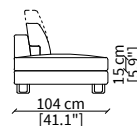
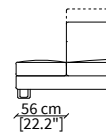

cod. 12127

Bracciolo **FLAT 74 cm** / Armrest **FLAT 74 cm**

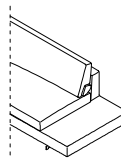
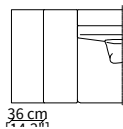
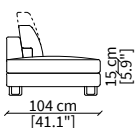
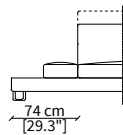

cod. 12129

Bracciolo **TOP FLAT 36 cm** / Armrest **TOP FLAT 36 cm**

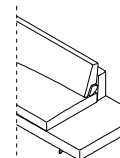
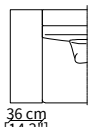
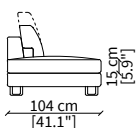
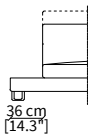

cod. 12130

Bracciolo **TOP FLAT 56 cm** / Armrest **TOP FLAT 56 cm**

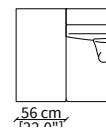
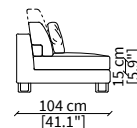
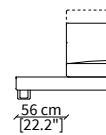

Dimensioni espresse in cm se non diversamente indicato.
L'Azienda si riserva il diritto di apportare modifiche ai modelli senza preavviso.
Tolleranza sulle misure indicate di +/- 2%.

Dimensions in centimeter if not differently indicated.
The Company reserves the right to change the models without any advance notice.
Tolerance on the given sizes +/- 2%.

PIEDINI / FEET



cod. L

Piedini L 101x10 cm / Feet L 101x10 cm

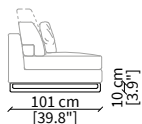
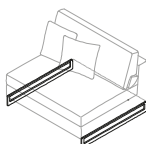

Piedino in metallo disponibile in differenti finiture. (Vedi pag. 19)

Metal foot available in different finishes. (See pag. 19)



cod. R

Piedini R 101x10 cm / Feet R 101x10 cm

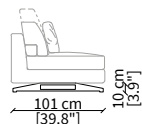
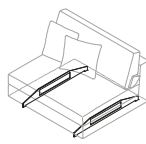

Piedino in metallo disponibile in differenti finiture. (Vedi pag. 19)

Metal foot available in different finishes. (See pag. 19)



cod. P

Piedini P Ø4,5x10 cm / Feet P Ø4,5x10 cm

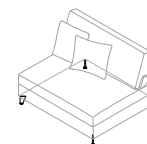

Piedino in metallo disponibile in differenti finiture. (Vedi pag. 19)

Metal foot available in different finishes. (See pag. 19)



cod. M

Piedini M 30x10 cm / Feet M 30x10 cm

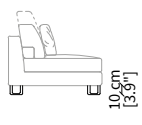
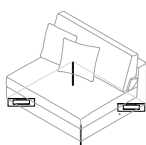

Piedino in metallo disponibile in differenti finiture. (Vedi pag. 19)

Metal foot available in different finishes. (See pag. 19)



cod. T

Piedini T 101x10 cm / Feet T 101x10 cm

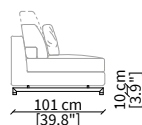
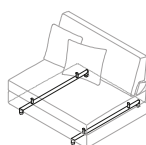

Piedino in metallo in nero sablé con puntale color oro. (Vedi pag. 19)

Metal foot painted black sablé with end tip in gold colour. (See pag. 19)

Dimensioni espresse in cm se non diversamente indicato.
L'Azienda si riserva il diritto di apportare modifiche ai modelli senza preavviso.
Tolleranza sulle misure indicate di +/- 2%.

Dimensions in centimeter if not differently indicated.
The Company reserves the right to change the models without any advance notice.
Tolerance on the given sizes +/- 2%.

SCHIENALI / BACK CUSHIONS



A.



Versione con cuscino schienale in posizione standard.
Seduta profondità **60 cm**.

Version with back cushion in standard position.
Seat **60 cm** deep.



B.



Versione con cuscino schienale rialzato.
Seduta profondità **71 cm**.

Raised back cushion version.
Seat **71 cm** deep.

Il divano Davis è caratterizzato da un cuscino schienale "patent pending" con movimento integrato, che nella versione rialzata incrementa lo spazio di seduta donando maggior comfort.

The Davis sofa is characterised by a back cushion "patent pending" with integrated movement, which in the raised version, increases the seating space and provides greater comfort.

SEDUTE / SEATS



GOOSE

Cuscino seduta con inserto in poliuretano indeformabile e trapuntino in piuma d'oca. La seduta, realizzata in un pezzo unico, assumerà con l'uso un aspetto più morbido e vissuto.

Seat cushion with core in non-deformable polyurethane foam covered with goose down quilt. The seat, realized in one piece, will look softer with everyday use.



POLMD

Cuscino seduta in poliuretano espanso indeformabile media densità e fibra sintetica ricoperti con fodera in cotone. La seduta, realizzata in un pezzo unico, assumerà con l'uso un aspetto più morbido e vissuto.

Seat cushion in medium density non-deformable polyurethane foam and synthetic fibre layer covered with cotton fabric. The seat, realized in one piece, will look softer with everyday use.



POLHD

Cuscino seduta in poliuretano espanso indeformabile alta densità e fibra sintetica ricoperti con fodera in cotone. La seduta, realizzata in un pezzo unico, assumerà con l'uso un aspetto più morbido e vissuto.

Seat cushion in hard density non-deformable polyurethane foam and synthetic fibre layer covered with cotton fabric. The seat, realized in one piece, will look softer with everyday use.

Dimensioni espresse in cm se non diversamente indicato.
L'Azienda si riserva il diritto di apportare modifiche ai modelli senza preavviso.
Tolleranza sulle misure indicate di +/- 2%.

Dimensions in centimeter if not differently indicated.
The Company reserves the right to change the models without any advance notice.
Tolerance on the given sizes +/- 2%.

TOP FLAT ACCESSORI / TOP FLAT ACCESSORIES



Il bracciolo Top Flat permette il posizionamento di una serie di accessori per realizzare composizioni multifunzionali e soddisfare le diverse esigenze di ogni stanza.

The armrest Top Flat allows the fitting of a series of accessories to create multifunctional compositions and meet the different needs of every environment.



TOP WOOD

Top in legno disponibile in due misure per essere appoggiato sul bracciolo Top Flat.

Wooden top available in two sizes to be placed on the Top Flat armrest.



TOP MARBLE

Top in marmo disponibile in due misure per essere appoggiato sul bracciolo Top Flat.

Marble top available in two sizes to be placed on the Top Flat armrest.

cod. 12430
Piano 102x34 cm
Top 102x34 cm

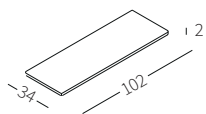

cod. 12431
Piano 102x54 cm
Top 102x54 cm

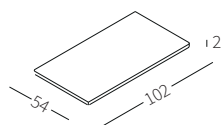

cod. 12430
Piano 102x34 cm
Top 102x34 cm

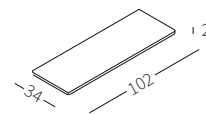

cod. 12431
Piano 102x54 cm
Top 102x54 cm

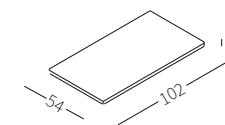

TRAY

Vassoio disponibile in due misure rivestito in cuoio per essere appoggiato sul bracciolo Top Flat.

Tray available in two sizes covered in hide-leather to be placed on the Top Flat armrest.



BOX

Elemento in legno disponibile in due misure per posizionamento su bracciolo Top Flat.

Wooden element available in two sizes to be placed on the Top Flat armrest.

cod. 12131
Vassoio 102x34 cm
Tray 102x34 cm

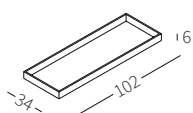

cod. 12132
Piano 102x54 cm
Top 102x54 cm

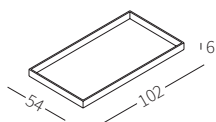

cod. 12432
Scatola 102x34xh22 cm
Box 102x34xh22 cm

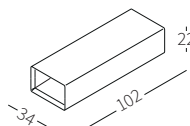

cod. 12433
Scatola 102x54xh22 cm
Box 102x54xh22 cm

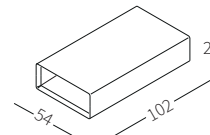

Dimensioni espresse in cm se non diversamente indicato.
L'Azienda si riserva il diritto di apportare modifiche ai modelli senza preavviso.
Tolleranza sulle misure indicate di +/- 2%.

Dimensions in centimeter if not differently indicated.
The Company reserves the right to change the models without any advance notice.
Tolerance on the given sizes +/- 2%.

POUF ACCESSORI / POUF ACCESSORIES



Al Davis pouf è possibile coordinare i braccioli Top Flat e Flat per soluzioni arredative inaspettate e innovative.

The pouf Davis could be used with armrests Top Flat and Flat for unexpected and innovative solutions.



TOP WOOD

Top in legno disponibile in due misure per essere appoggiato sul bracciolo Top Flat.

Wooden top available in two sizes to be placed on the Top Flat armrest.



TOP MARBLE

Top in marmo disponibile in due misure per essere appoggiato sul bracciolo Top Flat.

Marble top available in two sizes to be placed on the Top Flat armrest.

cod. 12430
Piano 102x34 cm
Top 102x34 cm

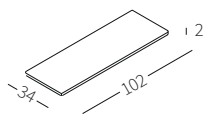

cod. 12431
Piano 102x54 cm
Top 102x54 cm

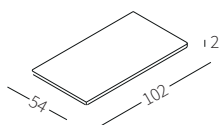

cod. 12430
Piano 102x34 cm
Top 102x34 cm

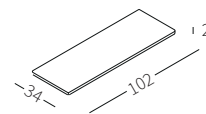

cod. 12431
Piano 102x54 cm
Top 102x54 cm

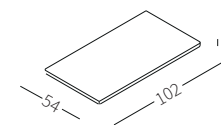

TRAY

Vassoio disponibile in due misure rivestito in cuoio per essere appoggiato sul bracciolo Top Flat.

Tray available in two sizes covered in hide-leather to be placed on the Top Flat armrest.



BOX

Elemento in legno disponibile in due misure per posizionamento su bracciolo Top Flat.

Wooden element available in two sizes to be placed on the Top Flat armrest.

cod. 12131
Vassoio 102x34 cm
Tray 102x34 cm

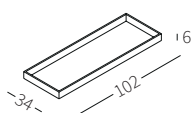

cod. 12132
Piano 102x54 cm
Top 102x54 cm

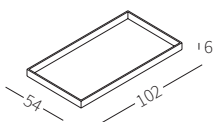

cod. 12432
Scatola 102x34xh22 cm
Box 102x34xh22 cm

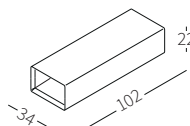

cod. 12433
Scatola 102x54xh22 cm
Box 102x54xh22 cm

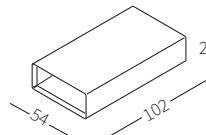

Dimensioni espresse in cm se non diversamente indicato.
L'Azienda si riserva il diritto di apportare modifiche ai modelli senza preavviso.
Tolleranza sulle misure indicate di +/- 2%.

Dimensions in centimeter if not differently indicated.
The Company reserves the right to change the models without any advance notice.
Tolerance on the given sizes +/- 2%.

ACCESSORI / ACCESSORIES



cod. 12181 - cod. 12188

Cuscino a libero posizionamento /
Freestanding backrest with cushion

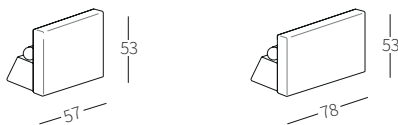

**SCHIENALE LIBERO POSIZIONAMENTO
FREE-STANDING BACKREST**

Lo schienale libero posizionamento, disponibile in due misure, può essere utilizzato in svariate situazioni per innovative soluzioni arredative.

The free-standing backrest, available in two sizes, could be used in different situations for innovative furnishing solutions.



cod. 13158 - cod. 13159 - cod. 13160

Fly

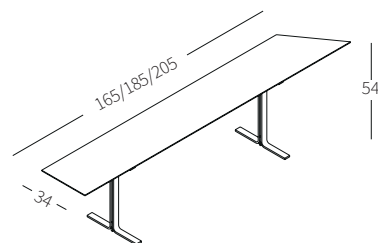

DAVIS FLY

L'elemento Davis Fly è un tavolo sagomato per l'utilizzo coordinato agli elementi terminali Fly per soluzioni retrodivano innovative e funzionali.

The Davis Fly element is a shaped table to be used coordinated to the Fly terminal elements for back-sofas innovative and functional solutions.



cod. 12525 - cod. TYDA

Cabinet 50x104cm con due vassoi 33x50
Cabinet 50x104 with two tray 33x50

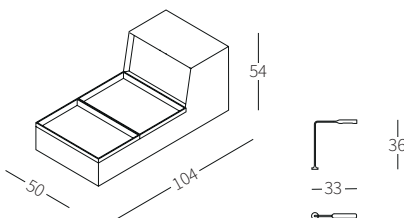

DAVIS CABINET - DAVIS LAMP

Elemento Cabinet in legno disponibile in varie finiture.

Cabinet element in wood available in different finishes.



cod. 12102

Schienale per angolo con cuscino /
Corner backrest with cushion

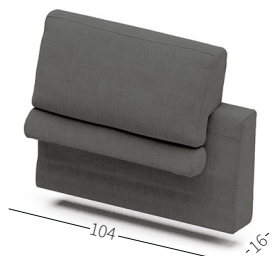

**SCHIENALE BACK
BACKREST CUSHION**

Lo schienale Back della collezione Davis è un elemento modulare innovativo che permette di risolvere situazioni angolari utilizzando al meglio lo spazio e garantendo l'imbattibile comfort della collezione.

The Back element from the Davis collection is an innovative modular element, which allows to solve corner situation by using the space at the best and by granting the unbeatable

DAVIS SYSTEM
Design Gianfranco Frigerio

ELEMENTI CENTRALI / CENTRAL ELEMENTS

cod. 12103

Elemento 100 cm / Element 100 cm

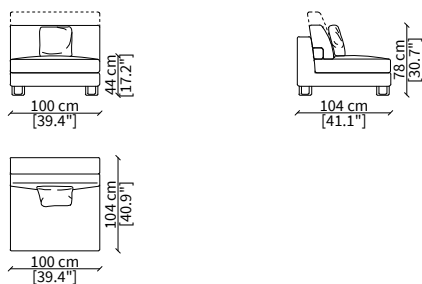

cod. 12104

Elemento 120 cm / Element 120 cm

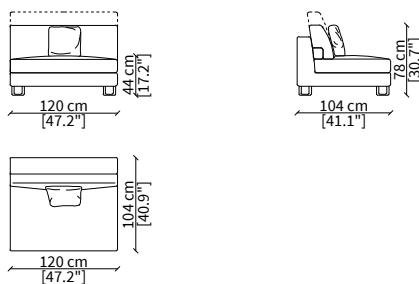

cod. 12105

Elemento 140 cm / Element 140 cm

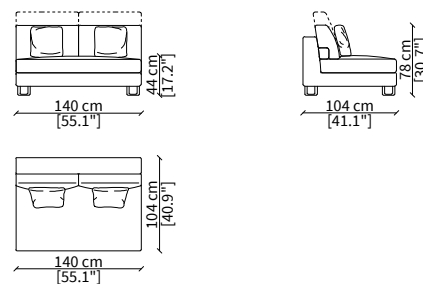

cod. 12106

Elemento 160 cm / Element 160 cm

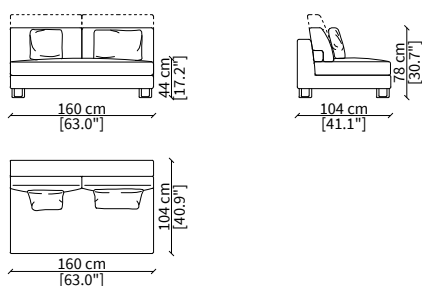

cod. 12107

Elemento 180 cm / Element 180 cm

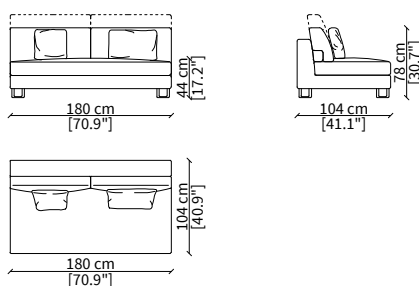

cod. 12108

Elemento 200 cm / Element 200 cm

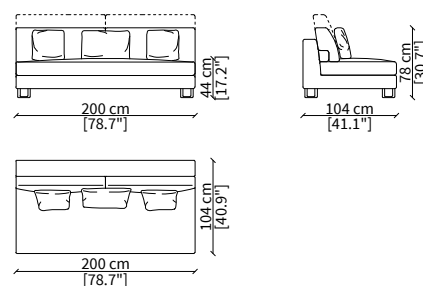

cod. 12109

Elemento 220 cm / Element 220 cm

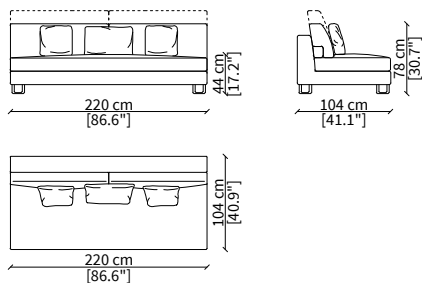

ELEMENTI DORMEUSE / DORMEUSE ELEMENTS

cod. 12116

Elemento 140 cm / Element 140 cm

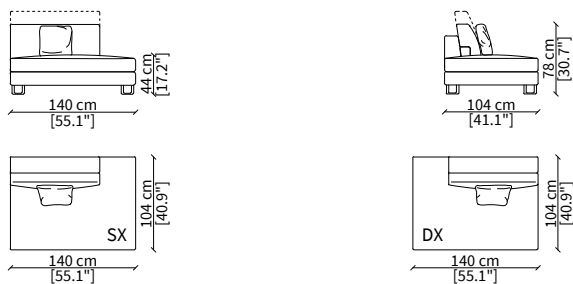

cod. 12117

Elemento 200 cm / Element 200 cm

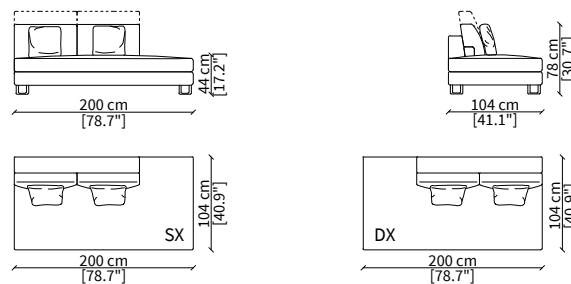

Dimensioni espresse in cm se non diversamente indicato.
L'Azienda si riserva il diritto di apportare modifiche ai modelli senza preavviso.
Tolleranza sulle misure indicate di +/- 2%.

Dimensions in centimeter if not differently indicated.
The Company reserves the right to change the models without any advance notice.
Tolerance on the given sizes +/- 2%.

ELEMENTO DORMEUSE POUF / COMFORT DORMEUSE POUF

cod. 12140

Elemento 244 cm / Element 244 cm

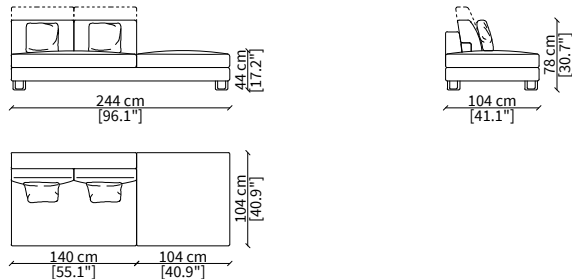

cod. 12141

Elemento 284 cm / Element 284 cm

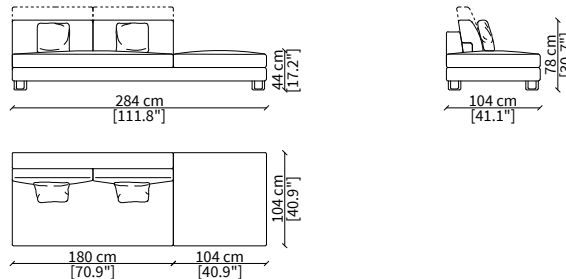

ELEMENTO DORMEUSE COMFORT / COMFORT DORMEUSE ELEMENT

cod. 12137

Elemento 193 cm / Element 193 cm

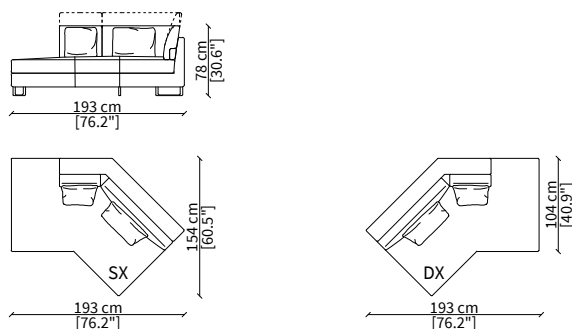

ELEMENTO COMFORT / COMFORT ELEMENT

cod. 12136

Elemento 193 cm / Element 193 cm

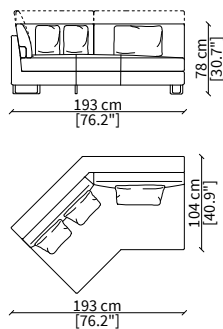

ELEMENTO CHAISE LONGUE / CHAISE LONGUE ELEMENT

cod. 12110

Elemento 100 cm / Element 100 cm

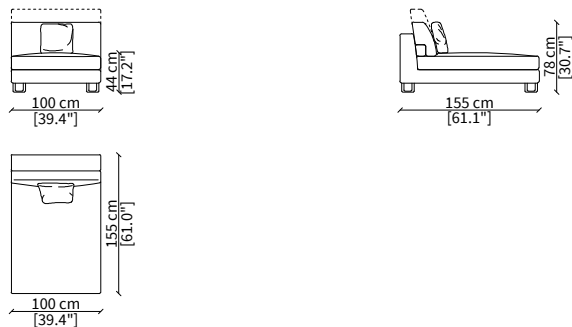

cod. 12111

Elemento 120 cm / Element 120 cm

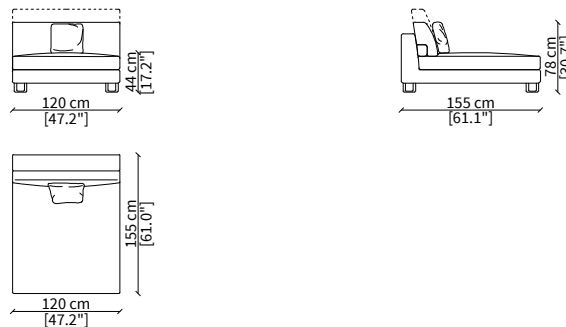

Dimensioni espresse in cm se non diversamente indicato.
L'Azienda si riserva il diritto di apportare modifiche ai modelli senza preavviso.
Tolleranza sulle misure indicate di +/- 2%.

Dimensions in centimeter if not differently indicated.
The Company reserves the right to change the models without any advance notice.
Tolerance on the given sizes +/- 2%.

ELEMENTI CHAISE LONGUE CON BRACCIOLO / CHAISE LONGUE WITH ARMREST ELEMENTS

cod. 12134

Elemento 100 cm bracciolo TWIN / Element 100 cm armrest TWIN

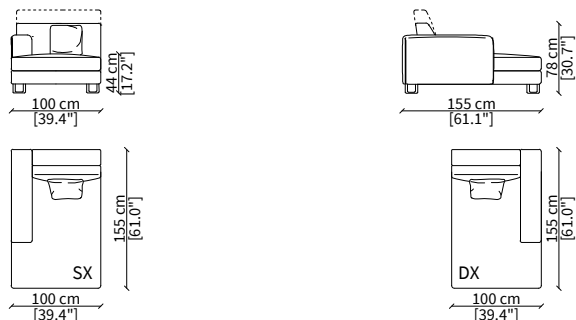

cod. 12135

Elemento 120 cm bracciolo TWIN / Element 120 cm armrest TWIN

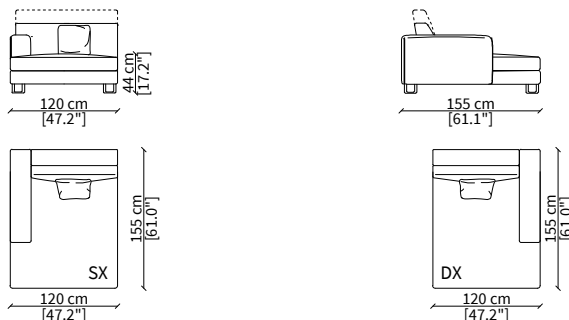

cod. 12607

Elemento 100 cm bracciolo STYLE / Element 100 cm armrest STYLE

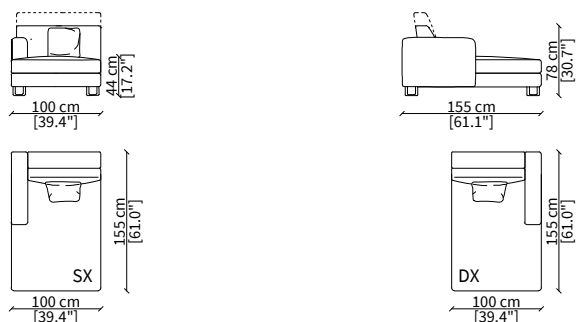

cod. 12608

Elemento 120 cm bracciolo STYLE / Element 120 cm armrest STYLE

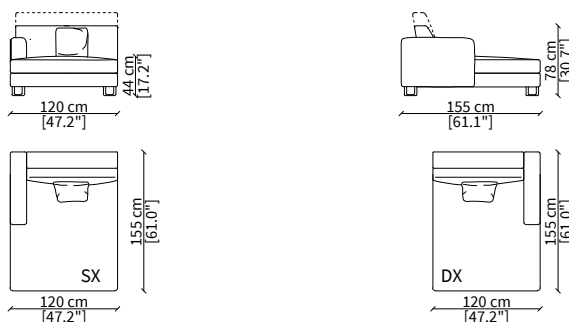

cod. 12609

Elemento 108 cm bracciolo SLIM / Element 108 cm armrest SLIM

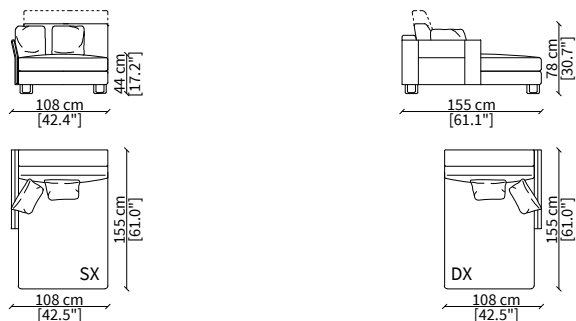

cod. 12610

Elemento 128 cm bracciolo SLIM / Element 128 cm armrest SLIM

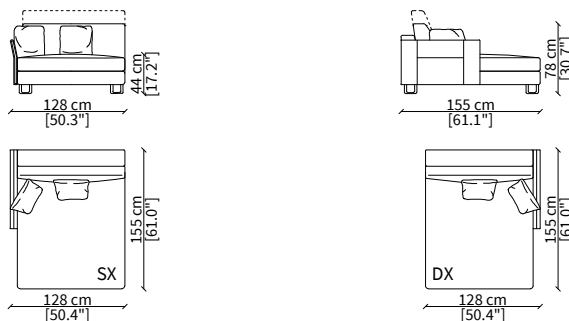

cod. 12605

Elemento 100 cm bracciolo WAVE / Element 100 cm armrest WAVE

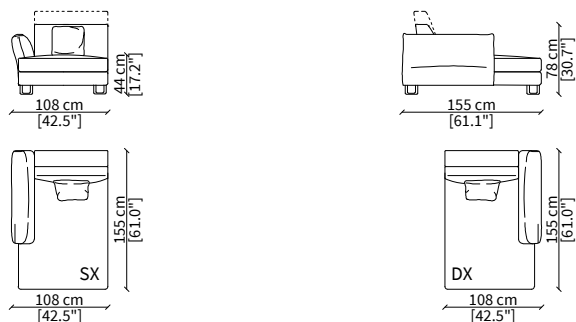

cod. 12606

Elemento 100 cm bracciolo WAVE / Element 100 cm armrest WAVE

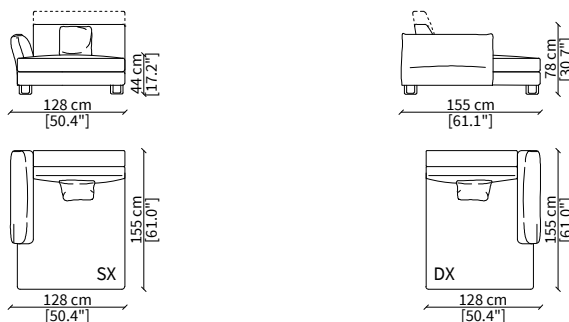

Dimensioni espresse in cm se non diversamente indicato.
L'Azienda si riserva il diritto di apportare modifiche ai modelli senza preavviso.
Tolleranza sulle misure indicate di +/- 2%.

Dimensions in centimeter if not differently indicated.
The Company reserves the right to change the models without any advance notice.
Tolerance on the given sizes +/- 2%.

cod. 12112

Elemento 100 cm bracciolo IN / Element 100 cm armrest IN

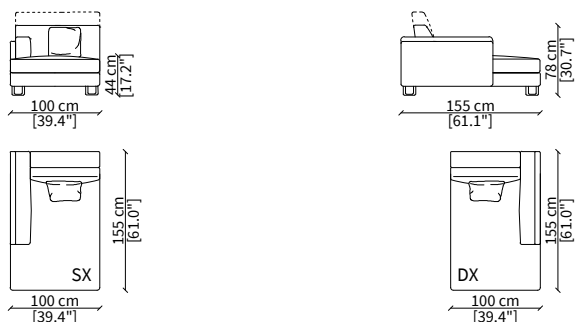

cod. 12114

Elemento 120 cm bracciolo IN / Element 120 cm armrest IN

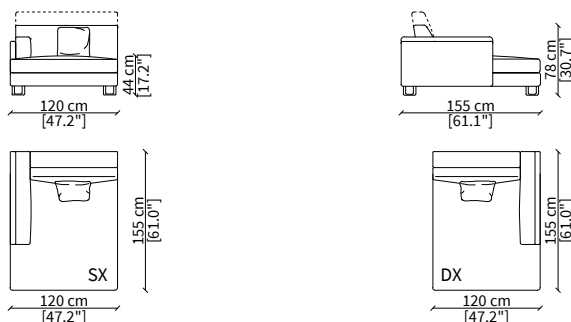

cod. 12113

Elemento 100 cm bracciolo OUT / Element 100 cm armrest OUT

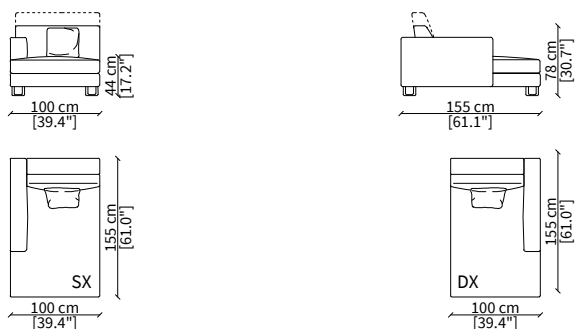

cod. 12115

Elemento 120 cm bracciolo OUT / Element 120 cm armrest OUT

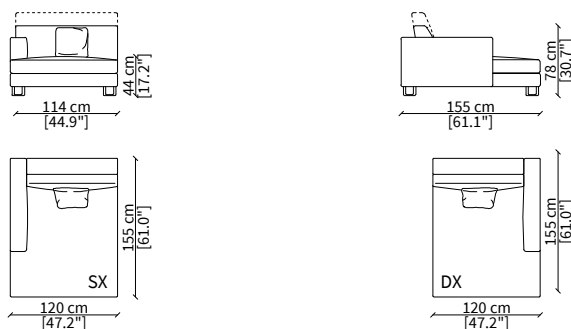

cod. 12122

Elemento 100 cm bracciolo FREE / Element 100 cm armrest FREE

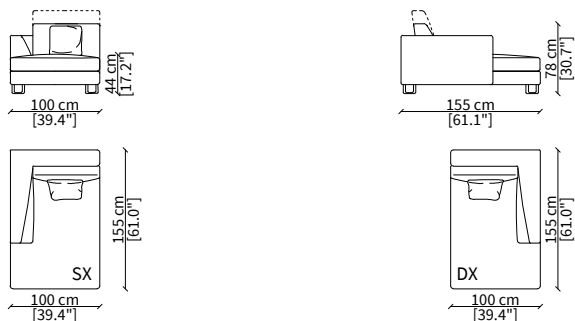

cod. 12123

Elemento 120 cm bracciolo FREE / Element 120 cm armrest FREE

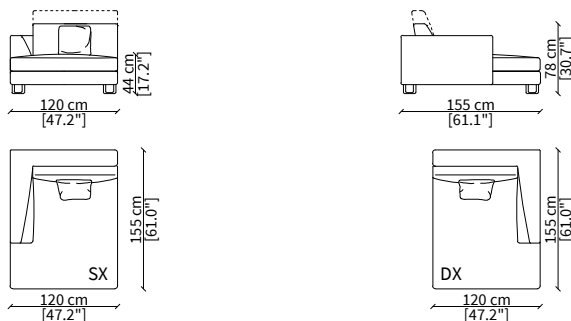

cod. 12142

Elemento 100 cm bracciolo CLASS / Element 100 cm armrest CLASS

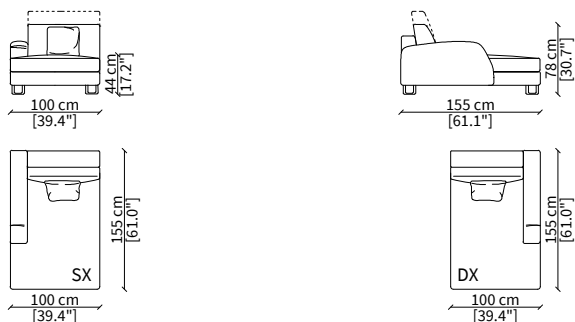

cod. 12143

Elemento 120 cm bracciolo CLASS / Element 120 cm armrest CLASS

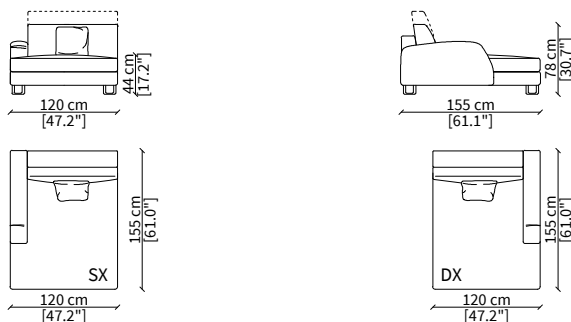

Dimensioni espresse in cm se non diversamente indicato.
L'Azienda si riserva il diritto di apportare modifiche ai modelli senza preavviso.
Tolleranza sulle misure indicate di +/- 2%.

Dimensions in centimeter if not differently indicated.
The Company reserves the right to change the models without any advance notice.
Tolerance on the given sizes +/- 2%.

ELEMENTI DORMEUSE TOP / TOP DORMEUSE ELEMENTS

cod. 12522

Elemento 244 cm / Element 244 cm

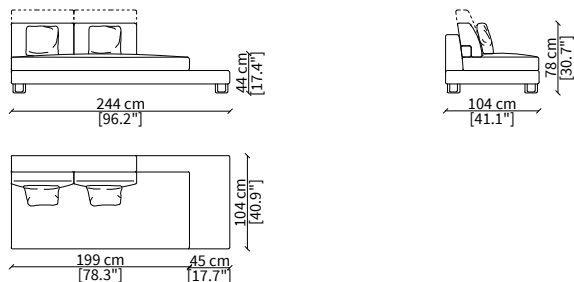

cod. 12523

Elemento 284 cm / Element 284 cm

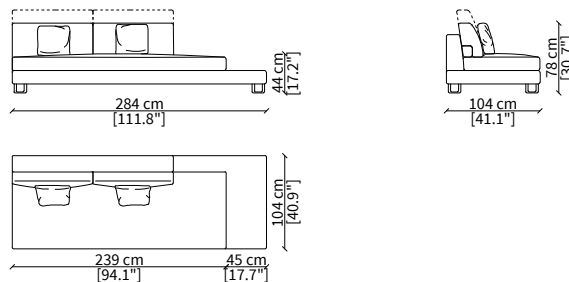

ELEMENTO TERMINALE PER TOP / TERMINAL ELEMENT FOR TOP

cod. 11335

Elemento 108 cm / Element 108 cm

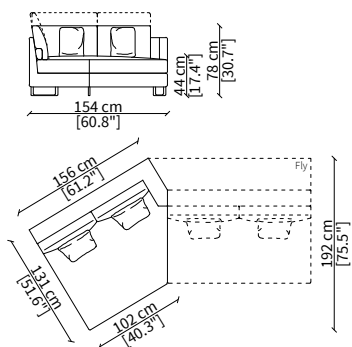

ELEMENTO ANGOLO / CORNER ELEMENT

cod. 12118

Elemento 104x104 cm / Element 104x104 cm

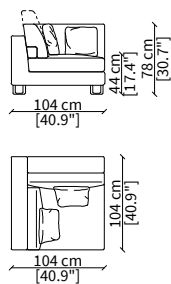

SCHIENALE PER ANGOLO CON CUSCINO / CORNER BACKREST WITH CUSHION

cod. 12102

Schienale per angolo con cuscino / Corner backrest with cushion

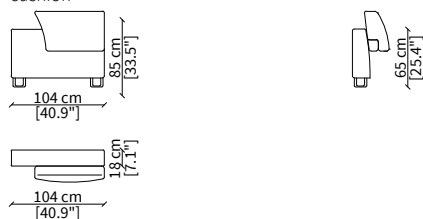

Dimensioni espresse in cm se non diversamente indicato.
L'Azienda si riserva il diritto di apportare modifiche ai modelli senza preavviso.
Tolleranza sulle misure indicate di +/- 2%.

Dimensions in centimeter if not differently indicated.
The Company reserves the right to change the models without any advance notice.
Tolerance on the given sizes +/- 2%.

POUFS

cod. 12119

Elemento 104x104 cm / Element 104x104 cm

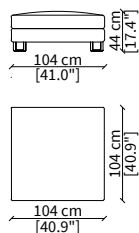

cod. 12518

Elemento 130x104 cm / Element 130x104 cm

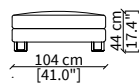
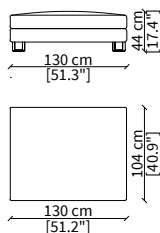

cod. 12121

Elemento 104x60 cm / Element 104x60 cm

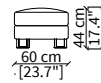
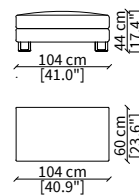

cod. 12145

Elemento 140x104 cm / Element 140x104 cm

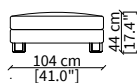
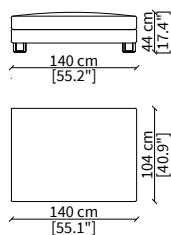

cod. 12146

Elemento 180x104 cm / Element 180x104 cm

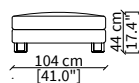
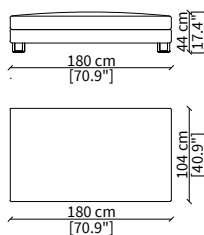

cod. 12147

Elemento 120x104 cm / Element 120x104 cm

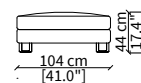
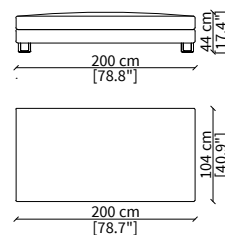

CUSCINI / CUSHIONS

cod. XP

Cuscino 40x40 cm / Cushion 40x40 cm



cod. XG

Cuscino 63x40 cm / Cushion 63x40 cm

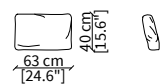

cod. 7441

Cuscino a libero posizionamento 57x53 cm
Freestanding backrest with cushion 57x53 cm



cod. 7442

Cuscino a libero posizionamento 78x53 cm
Freestanding backrest with cushion 78x53 cm

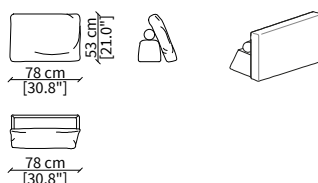

Dimensioni espresse in cm se non diversamente indicato.
L'Azienda si riserva il diritto di apportare modifiche ai modelli senza preavviso.
Tolleranza sulle misure indicate di +/- 2%.

Dimensions in centimeter if not differently indicated.
The Company reserves the right to change the models without any advance notice.
Tolerance on the given sizes +/- 2%.

PIANI / TOPS

cod. 12430

Piano 102x34 cm / Top 102x34 cm

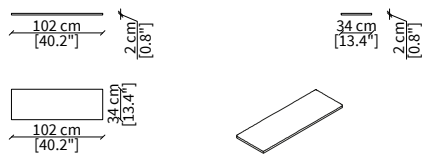

cod. 12431

Piano 102x54 cm / Top 102x54 cm

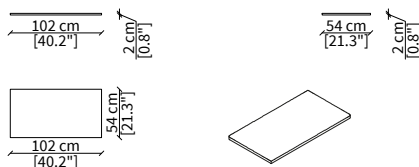

VASSOI / TRAYS

cod. 12131

Vassoio 102x34 cm / Tray 102x34 cm

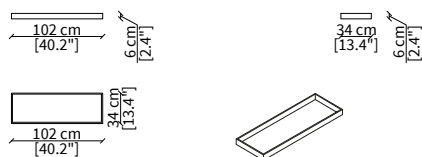

cod. 12132

Vassoio 102x54 cm / Tray 102x54 cm

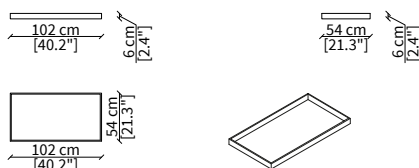

SCATOLE / BOXES

cod. 12432

Scatola 102x34x22 cm / Box 102x34x22 cm

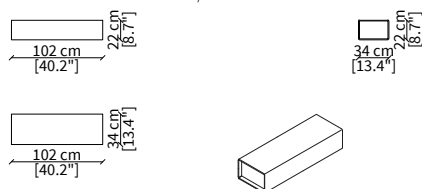

cod. 12433

Scatola 102x54x22 cm / Box 102x54x22 cm

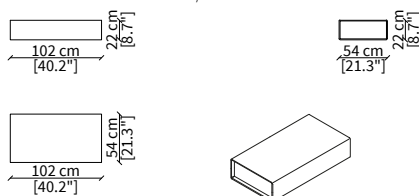

CABINET CON DUE VASSOI / CABINET WITH TWO TRAYS

cod. 12525

Cabinet 50x104 cm con due vassoi 33x50 cm
Cabinet 50x104 cm with two trays 33x50 cm

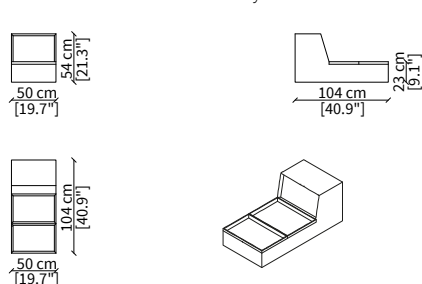

cod. TYDA

Lampada per cabinet / Cabinet lamp

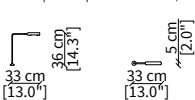

FLY

cod. 13158

Fly 140/165 cm

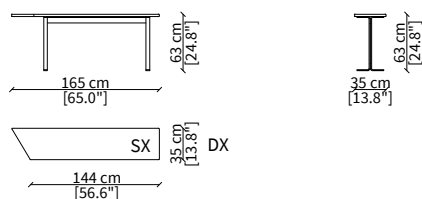

cod. 13159

Fly 160/185 cm

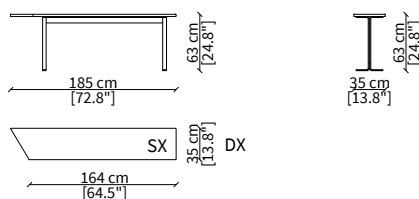

cod. 13160

Fly 180/205 cm

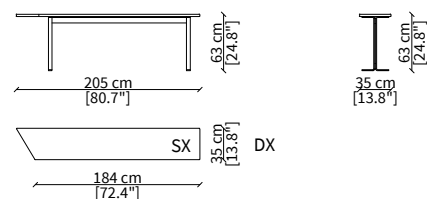

Dimensioni espresse in cm se non diversamente indicato.
L'Azienda si riserva il diritto di apportare modifiche ai modelli senza preavviso.
Tolleranza sulle misure indicate di +/- 2%.

Dimensions in centimeter if not differently indicated.
The Company reserves the right to change the models without any advance notice.
Tolerance on the given sizes +/- 2%.

DAVIS SYSTEM
Design Gianfranco Frigerio

TESSUTO / FABRIC



I colori visualizzati, per ovvie ragioni tecniche, sono indicativi e possono differire dall'originale.

Fare riferimento al listino prezzi per uso e disponibilità di ogni singola finitura.

The colours visualized, for obvious technical reasons, are indicative and may differ from the original.

Please refer to price list for use and availability of each finish.

TESSUTO / FABRIC

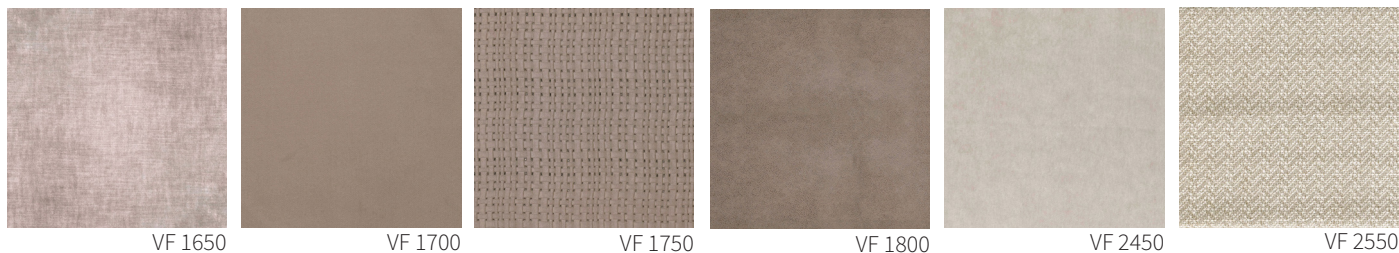

PELLE / LEATHER



CUOIO / HIDE LEATHER

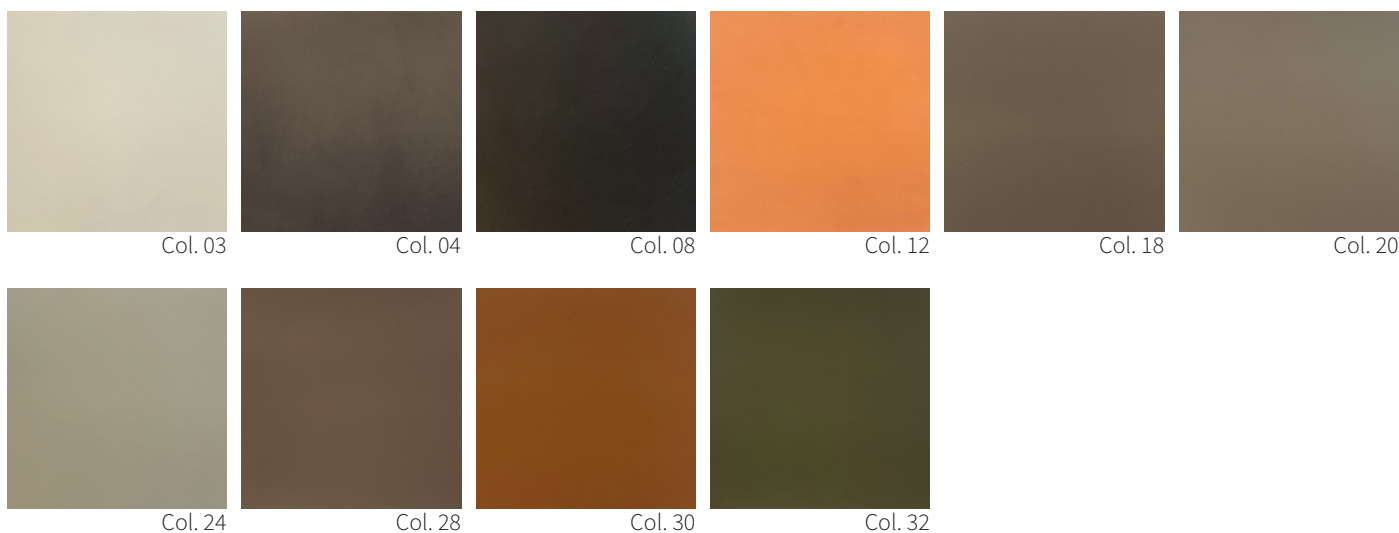

I colori visualizzati, per ovvie ragioni tecniche, sono indicativi e possono differire dall'originale.

Fare riferimento al listino prezzi per uso e disponibilità di ogni singola finitura.

The colours visualized, for obvious technical reasons, are indicative and may differ from the original.

Please refer to price list for use and availability of each finish.

ESSENZE / WOODS



Noce Canaletto
Walnut Canaletto

Frassino Sabbia
Ashwood Sand

Frassino Wengè
Ashwood Wengè

Frassino Greige
Ashwood Greige

Frassino Liquirizia
Ashwood Liquorice

Frassino Tabacco
Ashwood Tobacco

METALLI / METALS



Color Brunito
Burnished Colour

Color Greige Sablè
Greige Sablè Colour

Color Titanio
Titanium Colour

Color Grafite Lucido
Glossy Graphite Colour

Color Sabbia Sablè
Sand Sablè Colour

Color Antracite Lucido
Glossy Anthracite Colour

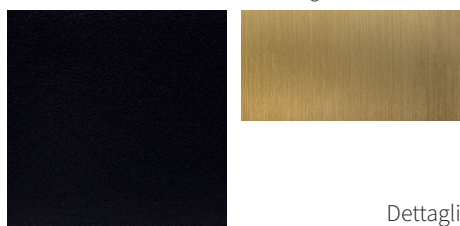

Color Nero Sablè
Black Sablè Colour

Dettagli
Verniciato Color Oro
Details Gold Colour

MARMI / MARBLES

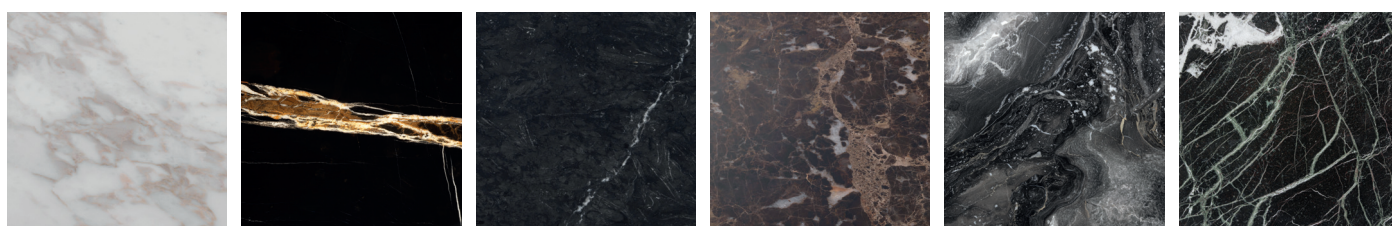

Calacatta Oro

Nero Sahara
Poliestere Lucido

Nero Marquina

Dark Emperador

Orobico

Verde Levanto

I colori visualizzati, per ovvie ragioni tecniche, sono indicativi e possono differire dall'originale.

Fare riferimento al listino prezzi per uso e disponibilità di ogni singola finitura.

The colours visualized, for obvious technical reasons, are indicative and may differ from the original.

Please refer to price list for use and availability of each finish.